

RADIO

ESTABLISHED 1917

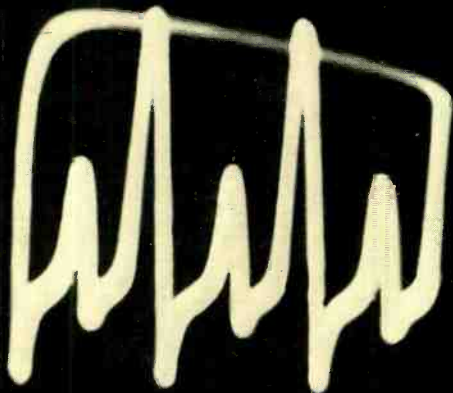

EXTENDED POSITIVE PEAK VOICE MODULATION

The Worldwide Authority of
Amateur and Short-wave Radio



December 1939

NUMBER 24

Bigger and Better Than Ever!

The new sixth edition of The Radio Handbook bears similarity to previous editions only in name and in the wide scope of material that is covered. This 1940 edition is not just the previous edition brought up to date; it is an enlarged and almost completely re-written reference manual on theory, construction, and operation of high-frequency and ultra-high-frequency radio equipment. Each chapter has been entirely re-outlined, new equipment shown, and most of the text re-written. Two new chapters have been added, Introduction to Amateur Radio, and Transmitter Construction.

Radio amateurs, servicemen, engineers and experimenters will find a wealth of valuable material, both new and fundamental, covered in the 640 big pages of this profusely illustrated book. The chapters on construction are alone well worth the price of the book to the radio amateur; the apparatus described employs the very latest in improvement, new ideas, and new components. Almost all the constructional material appears for the first time in this edition. The new equipment shown has been tested and proven under actual operating conditions.

The chapter headings themselves give a good indication of the subject material that is treated. They are, in order: Introduction to Amateur Radio; Introductory Electricity and Fundamental Radio Theory; Vacuum Tube Theory; Radio Receiver Theory; Receiver Tube Characteristics; Radio Receiver Construction; Transmitter Theory; Radiotelephony Theory; Transmitter Tubes; Transmitter Design; Exciters and Low-Powered Transmitters; Medium and High-Powered Amplifiers; Speech and Modulation Equipment; Power Supplies; Transmitter Construction; U.H.F. and Mobile Communication; Antennas; Test and Measurement Equipment; Workshop Practice; Radio Therapy; Radio Mathematics and Calculations; Radio Laws and Regulations; Appendix.

\$150 Continental U.S.A.

(From your dealer or pre-
paid direct from us!)

\$165 Elsewhere

THE EDITORS OF
RADIO *technical publishers*

1300 Kenwood Road, Santa Barbara
CALIFORNIA



1940 "RADIO" HANDBOOK
JUST PUBLISHED !

ORDER YOUR COPY FROM YOUR
FAVORITE DEALER
OR DIRECT FROM US !

MEMORANDA

RADIO

Handbook

SIXTH EDITION

7150
IN CONTINENTAL
U.S.A.
\$1.65
ELSEWHERE

RADIO

1300 Kenwood Road, Santa Barbara
CALIFORNIA

Phone: 4242

Cables: **RADIOLDT** SANTABARBARACALIF
Teletype: **S BAR 7390**

Branch Advertising
Offices:

NEW YORK, 71 W. 35th St.,
Phone: CHickering 4-7399

CHICAGO, 3606 N. Bernard St.,
Phone: JUNiper 5575

Production Office
for "RADIO"

EAST STROUDSBURG, PA., 30 N. Crystal St.
Phone: Stroudsburg 1734 Teletype: SDBG 74

The Editors of "Radio"

EDITOR

W. W. Smith, W6BCX

ASSOCIATE EDITORS

Ray L. Dawley, W6DHG

Frank C. Jones, W6AJF

Leigh Norton, W6CEM

K. V. R. Lansingh, W6QX

E. H. Conklin, W9BNX

CHICAGO

CONTRIBUTING EDITOR

Herbert Becker, W6QD

EDITORIAL AND TECHNICAL ASSISTANTS

Jack Rothman, W6KFQ

Kennard D. Moore, W6PDB

B. A. Ontiveros, W6FFF, Technical Draftsman

• • •

Business Staff

Santa Barbara

K. V. R. Lansingh, Publisher

A. McMullen, Managing Editor

Sales Department

**John Snetsinger, Circulation and Advertising
Manager; M. F. Zeis, Chief Subscription Clerk;**

R. Floberg, Chief Book Sales Clerk.

New York

V. R. Lansingh, Eastern General Manager

H. Olsher, Eastern Advertising Representative.

Chicago

C. W. Nelson, Asst. Advertising Manager

East Stroudsburg

**W. E. McNatt, Jr., W8TLJ,
Production Manager**

Advertising

Advertising inquiries may be directed to our nearest office. For fastest service prepare advertising copy in duplicate; send original copy and cuts (fully mounted and mortised) to East Stroudsburg, where "Radio" is printed; send duplicate copy, proofs of cuts, and space order to the advertising department at Santa Barbara. No advertisements will run until the home office telegraphs its approval.

Correspondence

Direct all manuscripts, subscription and book orders, payments, and general correspondence to the home office at Santa Barbara. Regarding advertising, see notice above. Unusable, unsolicited manuscripts will be destroyed unless accompanied by a stamped, addressed return envelope.

Rates

SUBSCRIPTION RATES: Two years, \$4.00, or \$2.50 yearly in U. S. A. (add 3% tax in California), Canada*, Newfoundland*, Cuba*, and Mexico*. To Pan-American countries and Spain, \$0.50* per year additional. Elsewhere (except New Zealand), \$1.00* per year additional. New Zealand only: 18s. 6d. yearly, local currency, from Te Aro Book Dept., Ltd., 64 Courtenay Place, Wellington. Special issues are included only with subscriptions of one-half year or longer. Refunds on cancelled subscriptions will be made at the difference between the rate paid and the rate earned.

THREE YEAR SUBSCRIPTIONS at the rate of \$5.00, net, in advance, are accepted from the U. S. A. and contiguous countries* only. Such subscriptions must be sent direct to our home office, not through agents. SINGLE COPY PRICES: Prices are for regular issues; prices for special issues may vary but are usually those shown in parentheses. At newsdealers, book stores, and radio parts dealers, 30c (50c) per copy in U. S. A. and Canada. By mail, postpaid, from home office, 30c (50c) in U. S. A., Canada*, Newfoundland*, Cuba*, and Mexico*; 35c (55c)* in other Pan-American countries and Spain. Elsewhere, 40c* (65c)*. BACK ISSUES, when available, 5c extra net. Back issues will not be included in subscriptions.

*REMITTANCES must be payable at par in continental U. S. A., except as follows: Add 10c plus exchange to Canadian checks, money orders and postal notes unless payable in U. S. dollars. From elsewhere, remit by bank draft (preferred) or international money order.

Miscellaneous Notices

IF YOU MOVE notify us in advance. We cannot replace copies sent to your old address. See "Changes of Address" notice elsewhere in this issue. RADIO is published ten times yearly (including enlarged special annual number) about the middle of the month preceding its date; August and September issues are omitted.

PUBLISHED BY RADIO, Ltd., Technical Publishers, 1300 Kenwood Road, Santa Barbara, California, U. S. A.

COPYRIGHT, 1939, by Radio, Ltd. All rights reserved. Reproduction without written permission is prohibited; permission is usually granted amateur radio papers on request. Printed in U. S. A.

TITLE REGISTERED at United States Patent Office.

RESPONSIBILITY will not be accepted for subscriptions placed with unauthorized agents. Prospective subscribers are urged to inspect carefully the credentials of anyone soliciting their business. Agents are never authorized to vary the rates quoted on this page.

BRANCH OFFICES transact a cash business with customers who call in person; mail and open account orders should be sent only to Santa Barbara.

Principal Foreign Agents

Europe: (Subscriptions) N. E. Read, 24 Church St., Oswestry, Shropshire, England; (bulk sales) International News Co., Ltd., 5 Breams Building, London, E. C. Australia: "The Bulletin", Box 2521BB, Sydney; McGills, 183 Elizabeth St., Melbourne; Swain & Co., Pitt St., Sydney. New Zealand: Te Aro Book Depot, Ltd., 64 Courtenay Place, Wellington. South America: F. Stark, Caixa 2786, Sao Paulo; "Revista Telegrafica", Peru 165, Buenos Aires; Editorial Pan America, Peru 677, Buenos Aires. South Africa: South African Radio Publications, 40 Trust Buildings, Fox Street, Johannesburg.

PRINTED IN U. S. A.

*The Worldwide Technical Authority of
Amateur, Shortwave, and Experimental Radio*

RADIO, December, 1939, No. 244. Published monthly except August and September by Radio, Ltd., 1300 Kenwood Road, Santa Barbara, California. Entered as second-class matter September 26, 1939, at the Post Office at Santa Barbara, California, under the Act of March 3, 1879. Additional entry at East Stroudsburg, Pa. Registered for transmission by post as a newspaper at G.P.O., Wellington, New Zealand.

WHAT

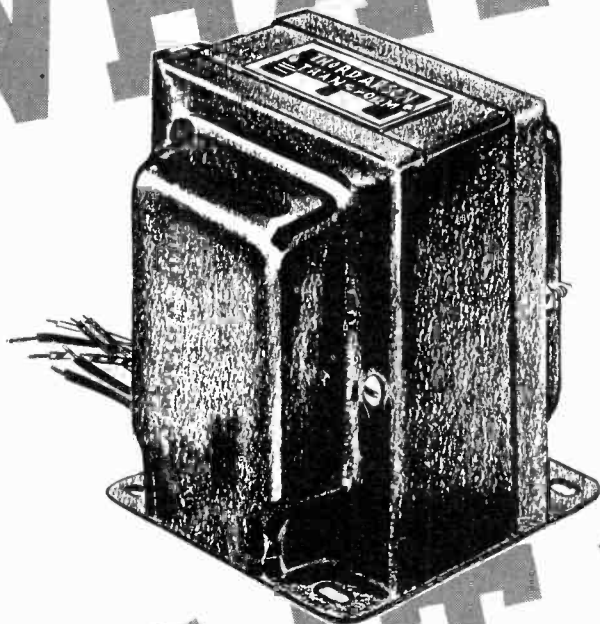

IS IT?

IT is the largest-selling Plate Supply Transformer in the world—the THORDARSON T-19P56! Ten pounds of the most scientifically engineered iron and copper—built with the ruggedness of Gibraltar, to give amateurs dependable service for years. Your favorite Parts Jobber has just the THORDARSON transformer you need for *any* purpose—transmitter or receiver. Ask your Parts Jobber for Catalog 400-D.

THORDARSON

Elec. Mfg. Co., Chicago

“THERE IS 44 YEARS OF EXPERIENCE BUILT INTO EVERY THORDARSON TRANSFORMER”

Past Present and Prophetic

Lop Sided Speech

Who would ever have thought that such a little thing as changing the microphone polarity would make any difference in the modulation capability of a transmitter? We wouldn't.

But when R.C.A. saw fit to incorporate provision for the automatic reversal of mike polarity in their transmitters, we decided to look into the matter. What we saw made our jaws drop about 6 db, which incidentally happens to be the gain provided by this system *with no increase in carrier*. What system? Why, extended positive peak voice modulation. You can read all about this astounding new innovation starting on page 11.

Keying by Request

There have been so many inquiries as to a good way to key an "e.c.o." or other type of v.f. (variable frequency) oscillator for break-in operation that we finally had to attack the problem in earnest. So far we haven't found any really simple method of completely eliminating "bloops" in a conventional v.f. oscillator when keyed. But the search led to a radically different form of oscillator which not only is capable of being keyed but also has a lot of other advantages. You will be seeing it in an early issue. In the meantime, it looks as though you will have to leave the key in the buffer jack.

Filament Modulation?

It appears from the favorable reception accorded it, that cathode modulation is destined for widespread popularity. All of which is very gratifying both to Mr. Jones and to RADIO.

In the course of some "lab gab" on the subject of cathode modulation, a new system was devised in which no coupling transformer is used. The rig has several other innovations and made everybody quite happy by showing a carrier efficiency of well over 50 per cent. Most of the time the output is hermetically sealed inside four Ohmite dummy

load resistors, but occasionally the rig is on the air. So if you hear any of the staff calls signing "Santa Barbara" on 75 or 20 meter phone, that's it. The rig uses a pair of 810's and is described on page 24.

Speaking of 810's calls to mind a postcard from a reader in Kansas who wants to know why it isn't called "filament modulation" when the tubes are not of the indirectly heated type.

"... Under the Sun"

Now a word in reply to the flood of letters from readers who want us to know that they "... invented cathode modulation way back in nineteen thirty something and can prove it by Joseph and William Doakes who saw it work, and where does Mr. Jones get that stuff? Anyhow?"

Yes, we know that cathode modulation is "old stuff"; but Mr. Jones made no claim for originality. His purpose was to show what a good bet was being passed up by the majority of amateurs and to give data on how to obtain maximum performance from this type of modulation. He was the first we know of to go about it in a scientific manner. He has shown that you can't just stick some audio in series with the cathode of any old r.f. amplifier and expect good results, but that when properly designed a cathode modulated transmitter will not only give excellent results but possess several advantages over transmitters using other types of modulation.

Splatter by the Platter Full

After sitting around a couple of days drawing doodles that resembled a wiring diagram we once received from Scratchi, the Technical Editor bestowed upon us the article on page 33. The bad interference caused by this type of "splatter" has been going on far too long, largely because we didn't know what was causing it or how to cure it. All the offending signal requires is a dose of Doctor Dawley's elixir of phased anti-pheedback, the prescription for which is given on the above mentioned page.

Antenna Score Sheet

Harold Taylor's antenna-tally sheet is one of those "why didn't someone write that up before" propositions. A record of this kind should be of great help to the chronic antenna experimenter, especially the fellow who starts out with a simple doublet and runs through the gamut of antennas from a to z, each antenna being far superior to its predecessor (so he says), only to discover that when he compares his idea of the ultimate in antennas with the original doublet the doublet works better in all directions.

[Continued on Page 96]

CHRISTMAS GREETINGS



from
Taylor Tubes



ONCE MORE the air is filled with the comforting message of Christmas. Into the hearts of everyone, the Christmas spirit brings a warm message of Peace, Good-Fellowship and Cheer. To radio amateurs,

in every country of the world, this spirit of brotherhood means a great deal and it is lived up to by them, faithfully day in and day out, through every season of the year. We, here at Taylor Tubes, know and respect this vital comradeship which the magic of amateur radio has made possible. To us—you, our loyal friends—represent a trust which we zealously and honestly serve. ❄️ Through Taylor Tubes the price of radio transmitting tubes has been brought within the reach of all. ❄️ Through us an absolute guarantee of satisfaction has been made a universal practice. ❄️ A friendly cooperative engineering staff has constantly served you. ❄️ Through Taylor research at our plant new and more efficient tubes have been created and placed at your service and here at Taylor Tubes the same spirit, which a QSO on the ham bands represents, completely governs our daily actions. It is small wonder then that we salute our many friends throughout the radio world, wishing them peace and the continued joy of close amateur friendship.

Yes, and to those men who so ably serve you—your Radio Parts Distributors—we extend our sincere thanks for carrying to the radio amateur, Taylor Tubes and the Taylor policy of fair play.

❄️ TO DAD, MOTHER, WIFE OR SWEETHEART ❄️

WE SUGGEST, as the ideal gift, Taylor transmitting tubes. Every radio amateur will welcome any of the many transmitting tube types made by Taylor Tubes. We will be happy to help you select such a gift, or see the parts distributor who serves your amateur, he will gladly help you.

BIG TAYLOR CHRISTMAS GIFT READY

YES, that big new 1940 Taylor Manual and Catalog will be ready for you before Christmas. Get your copy at your parts distributor free, or send us five cents in stamps or coin and we will mail it direct. Chock-full of New circuits—New tube uses—New tubes and all the latest transmitter data you want. Profusely illustrated with circuit diagrams, graphs and photos.



Merry Christmas and a Happy New Year

FRANK HAJEK W9ECA

WARREN TAYLOR

BILL BISHOP W9UI

JOE HAJEK

REX MUNGER W9LIP



"More Watts Per Dollar"

TAYLOR TUBES, INC., 2341 WABANSIA AVE., CHICAGO, ILLINOIS

they may look alike



but

... put to the test, all capacitors are *not* alike. They differ in life span, in number of advanced features, in dependability. Unfortunately the eye cannot see these important differences. There is a way, however, that you can be sure you're getting the all-around tops in capacitor value. Look for the name CORNELL-DUBILIER on the label. Only capacitors bearing this name are backed by laboratory *life tests* for performance, and the specialized experience of 29 manufacturing years — a guarantee of outstanding performance on the job.

demand

MICA
PAPER
DYKANOL
WET & DRY
ELECTROLYTICS

**CORNELL-
DUBILIER**

*a great name
in capacitors*



**CORNELL-DUBILIER
ELECTRIC CORPORATION**

1013 Hamilton Boulevard, South Plainfield, New Jersey

Cable Address: "CORDU"

The publishers assume no responsibility for statements made herein by contributors and correspondents, nor does publication indicate approval thereof.

Table of Contents

ARTICLES

Comes the Revolution— <i>W. W. Smith, W6BCX, and Ray L. Dawley, W6DHG</i> - - -	11
Cathode Modulation Operating Data— <i>Technical Staff of RADIO</i> - - -	16
Duo-Power Modulator— <i>Donald G. Reed, W6LCL</i> - - -	19
Series Cathode Modulation— <i>Ray L. Dawley, W6DHG</i> - - -	24
The "One Sixty"— <i>W. W. Smith, W6BCX</i> - - -	29
Reducing Splatter in Phone Transmitters— <i>Ray L. Dawley, W6DHG</i> - - -	33
Frequency Measurement on the Ultra Highs— <i>Keith J. Hayes, W9ZGD</i> - - -	35
"Pidgee"— <i>W. A. Woehr, W9WOP</i> - - -	36
Choosing the Swinging Choke— <i>C. A. M. Morgan, W9GCG</i> - - -	39
Analyzing Antenna Performance— <i>Harold E. Taylor, W8RNC</i> - - -	40
Inexpensive D.C. Relays from Old Auto-Radio Vibrators— <i>George M. Grening, W6HAU</i> - - -	42
Meet Your DX in Person— <i>Jo and Bill Conklin</i> - - -	44
Aural Compensation— <i>E. Carl Hall</i> - - -	51
Control System for C.W. and Phone - - -	52

MISCELLANEOUS FEATURES

Past, Present and Prophetic - - -	6	Marketplace - - -	97
Advertising Index - - -	96	Buyer's Guide - - -	98

DEPARTMENTS

DX - - -	55	New Books - - -	67
The Amateur Newcomer - - -	60	What's New in Radio - - -	68
U.H.F. - - -	62	The Open Forum - - -	70
Postscripts and Announcements - - -	66	Yarn of the Month - - -	72

**THE WORLDWIDE TECHNICAL AUTHORITY OF
AMATEUR, SHORTWAVE, AND EXPERIMENTAL RADIO**

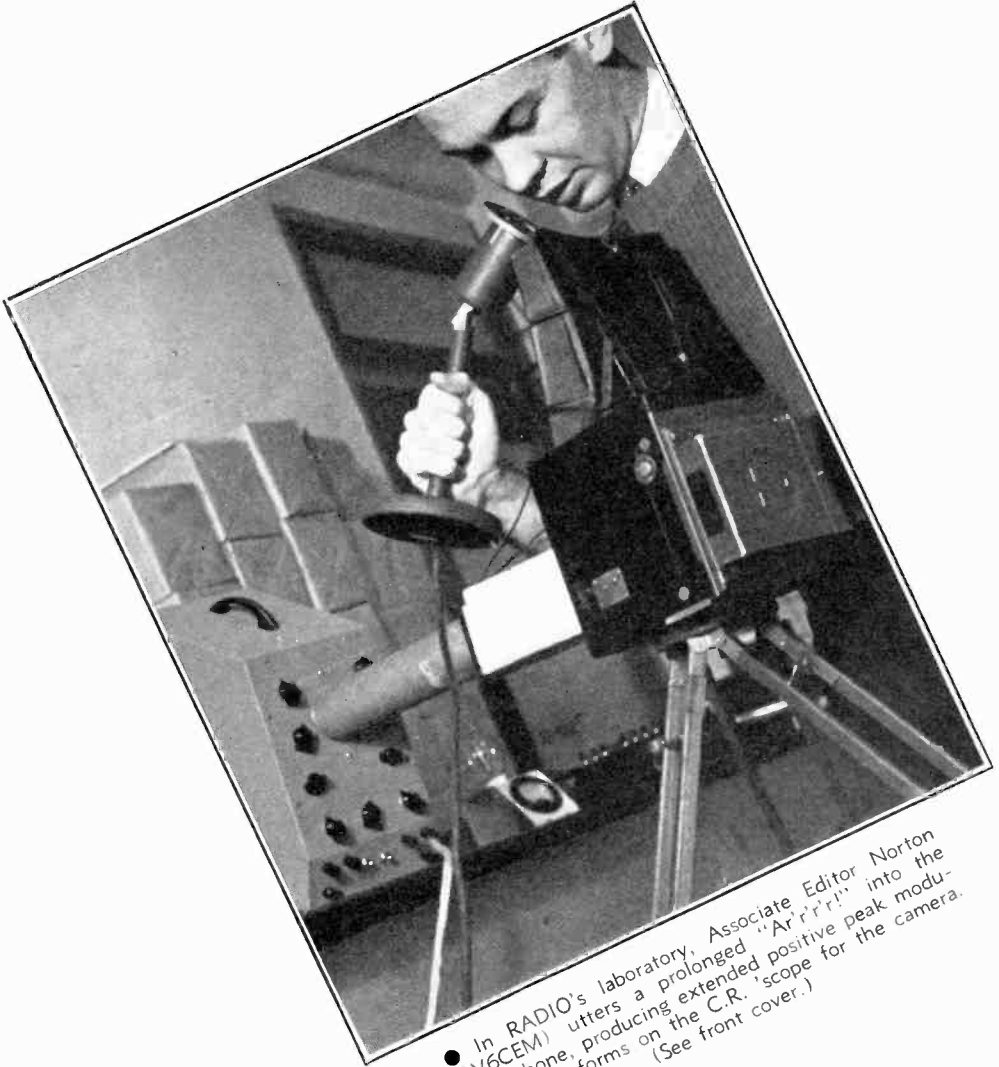

● In RADIO's laboratory, Associate Editor Norton (W6CEM) utters a prolonged "Ar r'r'r!" into the microphone, producing extended positive peak modulation waveforms on the C.R. 'scope for the camera. (See front cover.)

Comes the R E V O L U T I O N

A NEW CONCEPT OF VOICE MODULATION WHICH IS DESTINED
TO REVOLUTIONIZE AMATEUR TELEPHONY PRACTICE

By W. W. SMITH, W6BCX
and RAY L. DAWLEY, W6DHC

Application of a principle recently revealed by N.B.C. engineers results in practice so startlingly unorthodox as judged by old precepts that full advantage cannot be taken of its potentialities until the F.C.C. sees fit to change the wording of the present regulation pertaining to overmodulation.

Some time ago N.B.C. engineers observed with interest a peculiar characteristic of speech waveforms. When a male voice was fed into a high quality microphone which was connected to a speech amplifier with limited bass response, the speech waveform showed asymmetrical peaks.* In fact, when viewed on an oscilloscope the peaks proved to be about *twice as high in amplitude in one direction as in the other*, even though the *average* voltage of power was the same on either side of the axis. (See figure 1.) The degree of asymmetry varied slightly with different male voices, but practically all showed a difference of at least two to one. Female voices show less dissymmetry. Music shows practically none except for solos on certain instruments.

The extended peaks occur on the same side of the axis regardless of who is talking, though as noted above the degree of asymmetry may vary. By talking to the reverse side of a double-sided microphone (such as the ribbon type) or sucking the air inward while talking instead of letting it escape outward in a natural manner, the peaks will occur on the other side of the axis. However, one seldom has occasion for talking in such an *outré* manner, and most amateur micro-

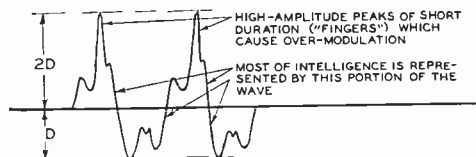

Figure 1.

Showing a section of speech waveform depicting a male voice. The maximum peaks extend twice as far on one side of the axis as the other, yet the energy on one side of the axis is equal to that on the other. The extended peaks always occur on the same side of the axis for a given microphone and speech system.

phones are designed to be actuated from only one side of the diaphragm. Therefore we may say that for all practical purposes the extended peaks always occur on the same side of the axis.

The reason for the asymmetry is all tied up with harmonic analysis and other abstruse factors, and will not be discussed here. The important thing is that the asymmetry exists and that it will eventually have far-reaching effect upon amateur phone transmitter design and adjustment. But before going further we shall review the conditions under which the pronounced asymmetry takes place:

(1) The microphone must be of high quality and have low inherent harmonic distortion (telephone microphones are "out").

* J. L. Hathaway, "Effect of Microphone Polarity on Percentage Modulation," *Electronics*, October, 1939.

(2) The voice must be of male timbre.

(3) The amplifier must have negligible response in the extreme bass register.

(4) The microphone must be spoken into at such a distance that reverberated pickup is negligible. When the microphone is spoken directly into at a distance of less than one foot there will be little reverberated pickup if the room has a normal amount of damping.

We see that the operator, equipment, and procedure of the average amateur phone station will fall in this classification, and the voice peaks will show a dissymmetry of two-to-one or greater. So we know that the maximum intensity voice *peaks* are about twice as high in one direction as the other when they emerge from the modulator, even though the *average* intensity is the same in both directions. The direction in which the maximum amplitude occurs may be reversed by changing either the primary leads or the secondary leads of any one transformer in the audio system. Reversing the polarity of the microphone leads will have the same effect. The importance of this asymmetry and the ability to fix its polarity will be apparent later.

Extended Positive Peak Modulation

It is evident that a modulated amplifier having 100 per cent modulation capability in both a positive direction and a negative direction will be overmodulated when the peaks of maximum intensity hit over 100 per cent in either direction. Thus with asymmetrical speech modulation it will be impossible to modulate in excess of 50 per cent in the direction of minimum amplitude peaks without hitting 100 per cent in the other direction. We can hit 100 per cent modulation either on positive peaks or on negative peaks simply by reversing the polarity of the modulating voltage, but whatever the polarity, the peaks on the "short" side will hit only 50 per cent.

It is interesting to note in this connection that when the modulation capability is limited to 100 per cent in both directions, it is impossible to voice-modulate over 75 per cent (as figured by the F.C.C. definition of percentage modulation) without *exceeding the modulation capability*. The same holds true when the voice modulating voltage is poled so that the extended peaks are downward, *regardless of the modulation capability in a positive direction*. In both cases voice modulation is limited to 75 per cent, because it is impossible to modulate over 50 per cent on the "short side" peaks without the "long side" peaks exceeding 100 per cent.

No modulated stage has a negative modulation capability in excess of 100 per cent, because it is impossible for the carrier to go "below zero." However, it is possible to design an amplifier to have a modulation capability in a positive direction of as much as 200 per cent. When such an amplifier is modulated by an asymmetrical speech wave having peaks which are twice as great in one direction as the other, *and the polarity of the modulating voltage is correct*, it is possible to hit peaks of 200 per cent in a positive direction without cutting off negative peaks. Thus we actually have 200 per cent modulation (in a positive direction) without carrier shift, distortion, or "splatter." The sideband power will be four times as great, which means that the signal will be as effective as would a signal with four times the carrier power and 100 per cent modulation capability in both directions. The mean modulation percentage would be 150 instead of 75. The interference caused by the extended positive peak type of signal would actually be *less*, because the carrier would be only one fourth as strong, and heterodyne interference would be reduced by six decibels. For the purpose of this article we shall refer to this type of modulation as "2/1 voice modulation."

Unfortunately, the present wording of the F.C.C. regulations is such that it is not only against the rules to modulate in excess of the modulation capability, but ". . . *in no case shall the emitted carrier be amplitude modulated in excess of 100 per cent.*"

This limitation of 100 per cent does not apply specifically to either negative or positive peaks, but to *mean* percentage modulation on peaks as defined by the F.C.C. definition of percentage modulation (ratio of half the difference between the maximum and minimum amplitudes of the amplitude modulated wave to the average amplitude, expressed in percentage). Therefore, if the modulation capability is extended sufficiently in a positive direction, it is possible to modulate 133 1/3 per cent in a positive direction and 66 2/3 per cent in a negative direction without exceeding 100 per cent modulation as defined by the commission (assuming no carrier shift is present).

Thus, while we can apply extended positive peak voice modulation and increase our mean modulation percentage from 75 per cent to a value of 100 per cent if there is sufficient (133 per cent) modulation capability in a positive direction (giving 1.7 times the sideband power or an effective power increase of 1.7 times), it is not possible to realize the full capabilities of the system, in which 200

per cent modulation is reached on positive voice peaks, until the F.C.C. sees fit to revise the wording of their ruling.

No doubt the wording will be changed to read in effect that the modulation percentage must not exceed 100 per cent *in a negative direction* nor exceed the modulation capability in either direction (meaning no carrier shift). Because with 2/1 speech modulation in which the mean percentage modulation hits 150 per cent (positive peaks 200 per cent yet negative peaks not clipped) it is possible to reduce heterodyne interference for a given sideband power on speech waveforms without introducing distortion or "splatter" (spurious radiations), it is felt that a revision in the wording will soon be forthcoming. In the meantime we can extend our positive voice peaks to 133 per cent and realize an equivalent power gain of 1.7 for a given carrier without violating the F.C.C. ruling.

Class C Amplifier Considerations

The positive modulation capability of many existing plate-modulated amplifiers is already in excess of 133 per cent. If the existing modulator is capable of delivering a reserve of audio without appreciable distortion, it may be necessary only to adjust the speech system for correct modulation polarity in order to take advantage of the 133 per cent positive peak modulation which at present is the legal maximum. To assure 133 per cent capability in a positive direction it is necessary only to increase the bias very slightly over that recommended by the manufacturer for plate modulation, maintaining the same grid current. The peak r.f. voltage appearing across the plate tank will be only slightly greater.

The positive modulation capability of a class C plate-modulated amplifier can be increased to approximately 200 per cent by increasing the bias to 1.5 times the value recommended for conventional plate modulation and running normal grid current for the amount of plate current being drawn. The peak r.f. voltage across the tank circuit in a 2/1 voice modulated transmitter hitting 200 per cent on positive peaks reaches a value 50 per cent greater than in the case of modulation reaching only 100 per cent on positive peaks. At first it might appear that the peak r.f. voltage across the tank would be 100 per cent greater, but the peak voltage is three (not four) times the carrier value, instead of twice the carrier value as would be the case with 100 per cent positive peak modulation. Thus with 200 per cent positive peak modulation the peak r.f. voltage across the tank is only 3/2 as great as with 100 per cent positive peaks.

Audio Considerations

We have seen that the sideband power in the case of a 2/1 modulated transmitter hitting 200 per cent on positive peaks is four times as great as for a transmitter running the same carrier but limited to 100 per cent modulation on positive peaks. However, we can't get something for nothing, and as the sideband component of our transmitted signal is represented by the audio power, a plate modulated class C stage will require four times as much peak audio power for maximum percentage 2/1 voice modulation as for conventional modulation in which peaks are held to 100 per cent.

This sounds as though a huge modulator would be required in order to realize the full capabilities of the 2/1 voice modulation system as applied to a plate modulated class C amplifier, and to an extent this is true. The modulator must be capable of delivering a large amount of *peak* power with very low distortion; but because the average power requirements will still be reasonable (due to the high ratio of peak power to average power with voice waveforms) the modulator need not be unduly large if push pull class B modulation is used. Such modulators are capable of delivering tremendous quantities of peak power.

Instead of using a pair of very small tubes in class B to modulate a pair of 100 watt tubes as is now common practice, a pair of 100 watt modulator tubes would be used. This would conform with practice prevalent when class B modulation was first introduced, when a pair of 203-A's in class B were used to modulate another pair in a class C amplifier. The trend has been towards smaller and smaller class B modulator tubes until today we might possibly use a pair of 809's at 1000 volts to voice-modulate a pair of 203-A's. But for 2/1 voice modulation it looks as though we might have to go back to the 203-A (or more modern equivalent) modulators.

The 2/1 system of voice modulation is going to appeal to the high power boys whose style is cramped by the present restriction of one kilowatt input, especially if the F.C.C. allows 200 per cent positive peaks. By incorporating 2/1 voice modulation they will be able to make as much noise as four kilowatts, yet their carrier and consequent heterodyne interference will be no greater than at present.

If you are having difficulty understanding why the 2/1 system of voice modulation permits an "effective power increase" of four times, look at it this way. Speech sounds

have an odd waveform; they contain recurring peaks that are of very short (almost instantaneous) duration yet of *much* greater amplitude than the average for the envelope. These "fingers" are what cause overmodulation; the average amplitude cannot be increased beyond a certain point without the "fingers" exceeding 100 per cent modulation. Oddly, for the male voice these "fingers" extend twice as far in one direction as the other on peaks of maximum intensity.

Now, we know it is possible to extend the modulation capability of an amplifier to a considerable extent in a positive (upward) direction. We can apply the modulation voltage in such polarity that the side having the double-length fingers modulates the amplifier in a positive direction (upwards). It is then possible to apply four times the audio power without "fingers" poking through either the floor or the ceiling (negative and positive modulation capability respectively), because twice as much voltage swing is possible without overmodulation.

It is obvious that if we have sufficient modulation capability in a positive direction, all we need to do to prevent overmodulation is to *avoid clipping the negative peaks*. Thus any a.m.c. circuits or overmodulation indicators should be of the *half-wave* type and work off the *negative peaks*.

While on the subject of clipping negative peaks, we might point out that many amateurs are now clipping negative peaks (causing bad "splatter") in an attempt to "modulate 100 per cent." Correct polarity of the modulating voice wave will greatly reduce this splatter by permitting 100 per cent modulation without clipping negative peaks. Modulation in a positive direction in excess of the positive modulation capability does not cause nearly as much interference as does clipping the negative peaks by the same amount. Another way of saying this is that even in a transmitter which does not have extended positive peak modulation capability it is preferable to overmodulate on the positive peaks rather than on the negative peaks, as less interference will result. This applies in particular to plate modulated transmitters, as they are more likely to have a positive modulation capability in excess of 100 per cent; but it also applies to grid modulated transmitters.

Illustrated in figure 2 is a simple method of using a cheap toggle switch in one of the audio stages to reverse the polarity of the modulating waveform. This permits an instantaneous reversal, which facilitates determination of proper polarity for a given microphone. The switch should not be placed

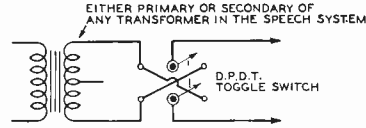

Figure 2.

Method of using an inexpensive toggle switch to permit instantaneous reversal of speech polarity. It can best be connected to the class B input transformer or to the grid modulation transformer. The voltage on the switch will then not be excessive, and the audio level will not be so low that shielded leads will be required.

in the low level stages because complete shielding would be required to avoid hum. Neither should the switch be placed across a transformer across which very high peak voltages occur, such as the class B output transformer, because the insulation is not sufficiently good on an inexpensive toggle switch. Perhaps the best place for the switch is across the secondary of a class B driver transformer or the secondary of a grid modulation transformer.

Applying the 2/1 System to Efficiency Modulation

Because practically all of the efficiency modulated amateur transmitters now in use are of the control grid modulated type (cathode modulation being a special type of control grid modulation), all remarks on efficiency modulation will be confined to grid modulation. To simplify the examples, straight control grid modulation will be assumed, though the remarks apply in substance to cathode modulation and all types of efficiency modulation.

In figure 3 are shown three conditions of operation for high efficiency grid modulated amplifier. The axis A is the maximum amplitude at which the output of the amplifier is linear with respect to bias. This point is determined by the antenna loading and plate voltage. In a typical grid modulated amplifier it corresponds to 80 per cent efficiency.

In frame 1 is shown a voice wave modulating the amplifier, the amplifier being adjusted for a carrier efficiency of just half the maximum peak efficiency. This is the customary method of adjustment, and allows 100 per cent sine wave modulation in both directions without exceeding the modulation capability in either direction. If axis A corresponds to 800 watts input and 80 per cent efficiency, then the carrier axis, C, corresponds to 400 watts input and 40 per cent efficiency. Thus the carrier power is one quarter the maxi-

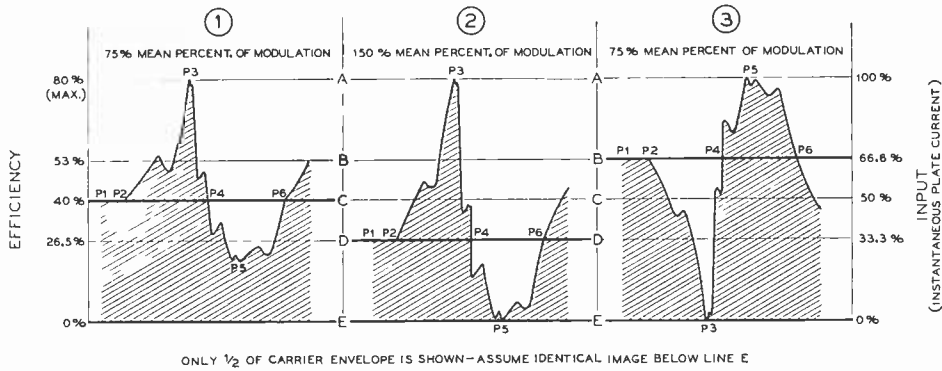

CARRIER EFFICIENCY	40 %	26.5 %	53 %	CARRIER EFFICIENCY
INPUT	400 W.	265 W.	530 W.	INPUT
CARRIER POWER	160 W.	70 W.	281 W.	CARRIER POWER
TUBE DISSIPATION	240 W.	195 W.	249 W.	TUBE DISSIPATION
SIDEBAND POWER	1 X	1.7 X	1.7 X	SIDEBAND POWER

Figure 3.

Illustrating why carrier efficiency of an efficiency modulated stage should be adjusted to one third maximum peak efficiency (frame 2) for voice work instead of to half the maximum peak efficiency as has been common practice (frame 1). Sideband power on voice waveforms is increased 1.7 times without overmodulation. Frame 3 shows a method of utilizing the entire operating range without violating the F.C.C. limitation on mean percentage of modulation to 100 per cent. In none of the three frames is the modulation capability exceeded. Operation as in frame 2 results in minimum heterodyne interference, but at the time of writing is illegal.

imum peak power, the normal condition for conventional telephony. We have a 160 watt carrier and 240 watts heating up the tubes when there is no modulation (the tubes will cool off slightly during modulation). When maximum positive voice peaks hit axis A, as at P₃, the mean percentage modulation is about 75 per cent. This value cannot be exceeded on voice without overmodulation.

If the polarity of the wave is reversed, the same conditions hold so far as maximum permissible percentage of modulation is concerned, because it will not be possible to modulate downward from C any farther than it is possible to modulate upward from C without exceeding the modulation capability. The distance from C to E is the same as C to A. The peak sideband power is determined by the distance from P₃ to P₅; so merely "flopping over" the wave will not affect the picture except that overmodulation will cause slightly less interference when the polarity is as in frame 1.

In frame 2 is shown the same amplifier with no changes made except that the bias is adjusted to put the carrier axis at D. No

changes are made in loading or plate voltage. The carrier efficiency is now 26.5 per cent, the input 265 watts, the carrier 70 watts, and the tube dissipation 195 watts. Instead of being one half the peak input power, the resting input is now one third the peak input. The distance from D to E is one half that from D to A. This means that it is possible to modulate twice as far upwards as it is downwards. The distance from P₂ to P₄ has been increased by 33 per cent. This means that the sidebands have been increased by the square of 1.33 or by 1.7 times. Thus we have less input, less carrier, less tube dissipation, yet nearly 2 times the sideband power. In fact we can increase the antenna loading or plate voltage to bring the tube dissipation up 23 per cent to what it was previously (240 watts). This will extend all the axes upward by 11 per cent, and the carrier and peak sideband power will go up 23 per cent. This will bring the maximum peak sideband power up to 2.1 times that obtainable with the type of operation shown in frame 1. Thus we see that simply

[Continued on Page 75]

CATHODE MODULATION

Operating Data

By the Technical Staff of RADIO

Concise data which permit one to design an efficient cathode modulated-amplifier and adjust it for maximum performance

Because it permits slightly greater carrier efficiency and is less critical of adjustment, cathode modulation is destined to supplant grid modulation to a large degree as a method of modulation requiring a comparatively small amount of audio power. While greater audio power is required for cathode modulation than for grid modulation, it is justified from the standpoint of economy because the carrier efficiency can be made slightly in excess of 50 per cent, instead of slightly less than 50 per cent as is common with high efficiency grid modulation. In an efficiency modulated amplifier the carrier power is limited by the plate dissipation; hence a slight increase in efficiency permits an appreciable increase in carrier power for a given tube.

Amplifier Circuit

The r.f. portion of a cathode modulated amplifier is basically no different from any conventional single ended or push-pull amplifier, as inspection of figures 1 and 2 will show. Because the audio power is fed into the filament return circuit instead of into the plate circuit or the grid circuit, the filament bypass condensers should not be made too large. These condensers are in shunt with the audio voltage and will by-pass the higher voice frequencies if they are of large capacity.

If push-pull tubes are used, it will be necessary to provide accurate balance of both excitation and load if twice the output obtainable from a single tube is to be obtained from the pair. If one tube receives slightly more excitation voltage than the other yet happens to be loaded slightly less than the other, it may be impossible to obtain more than 175 per cent of the output obtainable from a single tube. This applies to any type of efficiency modulation in which push pull tubes are used. Mechanical and electrical

symmetry throughout the amplifier will permit twice the output from push pull tubes.

Tubes

Best economy will be obtained with triodes. For best operation their amplification factor should be between 12 and 32. Because the maximum output will be determined by the plate dissipation, they should have a high ratio of plate dissipation to cost. Tubes costing more than 10 cents per watt of plate dissipation will not permit most economical design.

Plate Voltage

For maximum efficiency the tubes should be run at the maximum plate voltage recommended by the manufacturer for c.w. telegraphy, though there is no need to go above 2000 volts for inputs under 500 watts, nor over 3000 volts for inputs under 1000 watts.

Tank Condensers

The grid tuning condenser can be of the receiving type (.03 in. spacing) for low and medium power, .05 in. spacing for over 750 watts. The grid tank should not be too low C.

The plate tank condenser should have a plate spacing of at least twice the plate voltage if the circuit of figure one or figure two is used. Thus a condenser with a per-section spacing of 3000 volts will be satisfactory up to 1500 plate volts, assuming it is connected as shown.

Bias

The bias may be obtained from batteries, a bias pack, a grid leak, or a combination of a grid leak and battery. The bias should be at least 3 times cutoff. If obtained from a bias pack, it should be well filtered. Perhaps the most practical arrangement is sufficient battery bias to limit the plate dissipa-

impedance (this is figured the same as for a plate modulated amplifier). The cathode impedance is the portion between A and C. Use the closest tap on the transformer. Thus if the amplifier draws 220 ma. at 1100 volts, the plate impedance would be 5000 ohms and the correct cathode impedance one tenth of this value or 500 ohms. Any tap on the transformer between 350 and 700 ohms would work equally well. Still greater mismatch can be tolerated if there is a reserve of audio power.

Grid Tap

With tubes having a μ of 12-16 the same voltage swing may be applied to both grid and plate circuits. In this case the bias tap (B) would attach to the same point on the transformer as C. Thus A-B and A-C would be the same impedance.

For higher μ tubes, it is preferable to apply a smaller a.f. swing to the grid circuit than to the plate circuit. This is done by tapping the bias lead (B) at a point up from ground.

For tubes having a μ of 17-23 the impedance between A and B should be approximately 0.6 that of A-C. This does *not* mean 0.6 of the turns, as the impedance varies in proportion to the *square* of the number of turns. If A-C is 1000 ohms, then A-B would be approximately 600 ohms.

For tubes having a μ of 24-32 the impedance between A and B should be approximately 0.4 that of A-C.

When figuring impedances remember that if a tap is 800 ohms up from one end of a 1000 ohm winding, the impedance between the tap and the other end is *not* 200 ohms. All impedances should be figured from a common point to avoid a mixup on this score. In the diagrams the common point is the cathode tap (A). All impedances should be figured from this end.

Grid Current

The exact value of grid current will vary in different installations, and the proper amount must be determined by experiment. For small tubes it will usually run about 5 ma. per tube for low μ tubes and 8 or 10 ma. for high μ tubes. For large tubes it will run about 10 ma. per tube for low μ tubes and about 15 ma. per tube for high μ tubes.

These figures can be used to get an idea as to the correct size of grid resistor to use in order to get a bias of at least three times cutoff. The actual value of the grid resistor should be about twice the calculated value, with provision for varying it. Several "slider"

taps and a small selector switch can be used to provide sufficient adjustment. Use as much resistance as will still permit sufficient grid current under load. The resistor should have a dissipation rating equal to the maximum output of the exciter. This is necessary because ordinarily only a portion of the resistor will be used.

If battery "safety bias" is used in addition to a grid leak, calculate the resistance as follows: Multiply the calculated bias by two, subtract the battery bias, and from the expected grid current determine what resistance will give this voltage. The resistor should be provided with about five taps.

TUNING

Comparatively heavy antenna loading is necessary with cathode modulation, or the positive modulation capability will not be sufficient when the excitation is increased until the tubes draw the calculated plate current. If the antenna loading is *too* heavy for a given plate current, the efficiency will suffer. The idea is to keep increasing the antenna coupling until 100 per cent modulation capability is obtained when the excitation is adjusted for normal plate current, but do not increase the antenna coupling beyond this point.

It will sometimes be found that the modulation capability can be improved for a given degree of antenna coupling by shunting the grid tank with carbon "swamping resistors". The optimum resistance will be between 5000 and 25,000 ohms for single ended stage, and double this value for a push pull stage. The best value can be found only by experiment. Several resistors can be used in series or parallel to get sufficient dissipation ability when high power is used. They are connected right across the grid tuning condenser. A single 2-watt resistor will suffice in a low power amplifier. With a swamping resistor, somewhat tighter coupling to the driver will be required.

Extended Positive Peak Modulation

A cathode modulated amplifier may be adjusted for extended positive peak modulation for voice work (see article on page 24) as follows:

Tune up the amplifier as just described for 100 per cent symmetrical sine wave modulation capability, using an audio oscillator or whistle. Then reduce the excitation until the desired carrier axis is obtained and fix polarity of modulating voltage so that maximum intensity peaks on voice occur in a positive (upward) direction.

[Continued on Page 79]

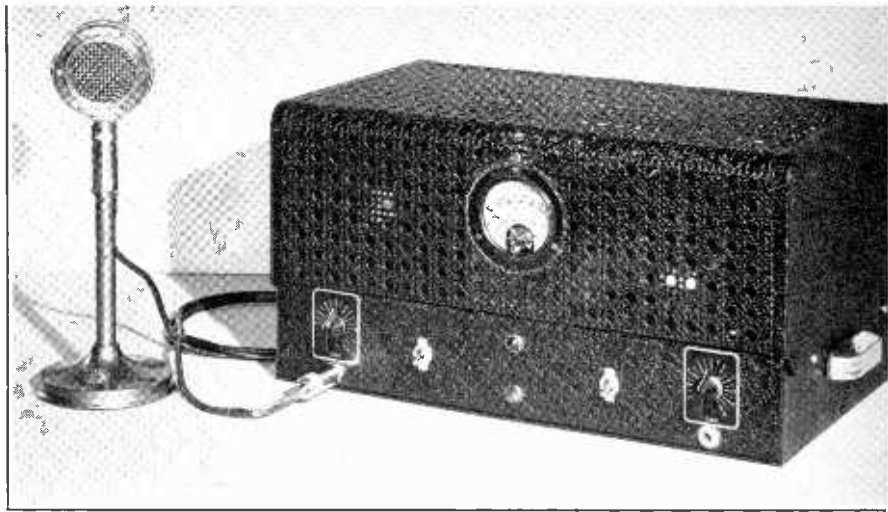

DUO-POWER MODULATOR

By DONALD G. REED,* W6LCL

Many phone amateurs who have made provision for cutting down the input to the final stage when making a local contact have found difficulty in reducing the modulator power proportionately without impairing the audio quality. The distortion of a class B modulator when operated at low level is comparatively high. Through the use of an arrangement such as that shown in the modulator described herein the power capability of the audio system may be reduced by any desired ratio from 3-1 to 10-1 and the quality of output of the modulator may be maintained.

In the January issue of RADIO there appeared a very fine low power speech amplifier-modulator under Ray Dawley's name. Since that time many quite satisfactory reports have been heard concerning the performance of the job. One thing seemed to be outstanding; this was the unusual freedom from bugs experienced by those who have built up and are using the piece of equipment.

Dawley called attention to several possible uses for this particular amplifier. But he did not recommend its use for driving a class B modulator as long as the output tubes were pentode connected, unless degenerative feedback were also incorporated.

If the full 25 watts output of the push-pull pentodes were needed to act as driver for a higher power class B stage, there is no

question of the inadvisability of trying such an act. But the possibility of using considerably less than the full capabilities of the pentodes was entirely too intriguing to forget.

With this thought in mind the present "duo-power" modulator was constructed. It is possible either to use the amplifier as a low power modulator as originally designed, or to cut in a higher power stage using class B 809's.

When the high power condition is in use, we find that the gain control of the speech amplifier section can be greatly reduced. The pentodes are sufficiently powerful to drive the class B stage to full output while they are operating at much less than maximum output.

To be certain of the facts, a thorough check-up of each stage was made with an oscilloscope. With sine-wave input each stage

* 2454 Lyric Ave., Los Angeles, Calif.

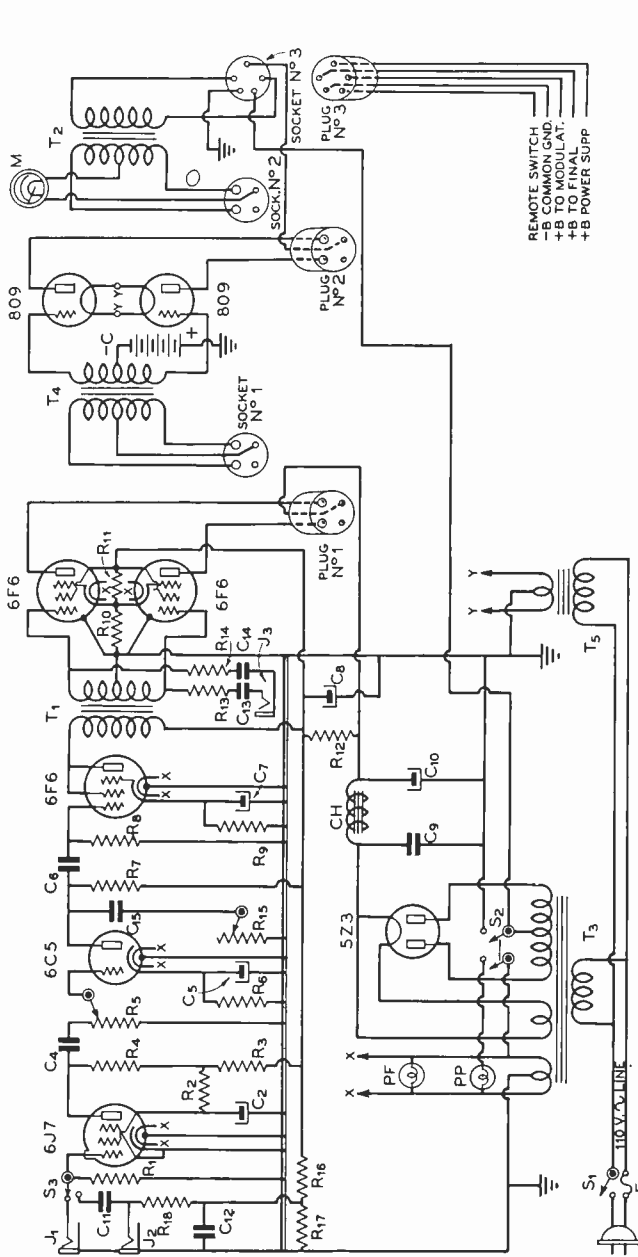

REMOTE SWITCH
-B COMMON GND.
+B TO MODULAT.
+B TO FINAL
+B POWER SUPP

Wiring diagram of the dual-power modulator.

- C₂—4- μ fd. 450-volt elect. paper
- C₁—.05- μ fd. 400-volt paper
- C₃—10- μ fd. 25-volt elect. paper
- C₄—0.1- μ fd. 400-volt paper
- C₅—10- μ fd. 25-volt elect. paper
- C₆—8- μ fd. 450-volt elect. paper
- C₇—4- μ fd. 600-volt paper
- C₈—8- μ fd. 600-volt elect. paper
- C₉—.05- μ fd. 200-volt paper
- C₁₀—0.1- μ fd. 600-volt paper
- C₁₁, C₁₃, C₁₄—0.1- μ fd. 400-volt tubular
- C₁₂—0.05- μ fd. 600-volt tubular
- R₁—3 megohms, 1/2 watt
- R₂—1 megohms, 1/2 watt
- R₃—50,000 ohms, 1 watt
- R₄—250,000 ohms, 1 watt
- R₅—250,000-ohm potentiometer
- R₆—2500 ohms, 1 watt
- R₇—50,000 ohms, 1 watt
- R₈—200,000 ohms, 1 watt
- R₉—750 ohms, 10 watts
- R₁₀—250 ohms, 10 watts
- R₁₁—10,000 ohms, 10 watts
- R₁₂—2000 ohms, 25 watts
- R₁₃, R₁₄—250,000 ohms, 1 watt
- R₁₅—500,000-ohm potentiometer
- R₁₆—15,000 ohms, 10 watts
- R₁₇—150 ohms, 1 watt
- R₁₈—250 ohms, 1/2 watt
- T₁—1.7/1 pri.-to-1/2 sec. match
- T₂—125-watt mufti-match
- T₃—880 c.t., 125 ma.; 6.3 v., 3.3 a.; 5 v., 3 a.
- T₄—Class B input to 809's
- T₅—6.3 volts, 6 amperes
- CH—9.5-hy., 110-m.a. choke
- PF—Filament pilot lamp
- PP—Plate pilot lamp
- J₁—Crystal mike jack
- J₂—Carbon mike jack
- J₃—Monitoring jack
- R₁₁-C₁₁—Tone control
- S₁—S.p.s.t. line switch
- S₂—D.p.s.t. plate switch
- S₃—Mike input switch
- Plugs and Sockets—See text

Top view of the dual-powered amplifier chassis with the dust cover removed. The plugs and sockets which accomplish the changeover from low to medium power can be seen on the left of the back drop of the chassis.

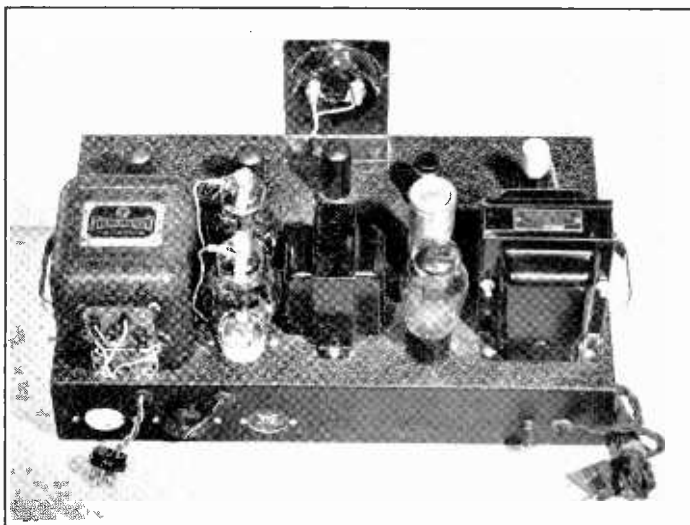

was successively tested. No trace of distortion made appearance in any stage until an output of approximately 120 watts from the 809's was reached. Whether this distortion was due to saturation of the 100-watt output transformer or to some other cause was not investigated; we were only expecting 100 watts output in the first place. Even at 120 watts output it is doubtful if the distortion would be noticeable to the ear as the sine wave was only slightly frost bitten.

Tube Line-Up

In the original story, the tubes were partly metal and partly glass. Here, a complete metal complement was used in the low power section to allow a more balanced chassis layout. From left to right we have a 6J7 input stage, with either a crystal or single-button carbon microphone input. This will be discussed later. The gain control is in the grid of the next stage, a 6C5, which in turn is capacity coupled to a triode-connected 6F6. The 6F6 triode is transformer coupled to the push-pull 6F6 stage, which acts as the low power modulator, or as driver for the class B 809's. In either operating condition the output is delivered from the secondary of the multimatch output transformer.

The Plug and Jack System

The diagram shows the leads from the plates and B plus of both power stages brought out to plugs through the back drop of the chassis, where are also located three

sockets. Socket no. 1 connects directly to the class B input transformed T₄. Socket no. 2 connects to the primary of the output transformer T₂, with a 0-300 d.c. milliammeter in series with the B plus lead to the centertap.

When using the high power line-up the plugs are inserted in their correspondingly numbered sockets. Plug no. 3 and its socket cannot be wrongly connected, as they are of the 5-prong variety. They are intentionally made different from the other two, which are of the 4-prong type, as they cannot be interchangeable.

To shift to low power, remove plugs 1 and 2 from their sockets and insert plug 1 in socket 2. This feeds the 425 volts from the low power supply through the primary of the output transformer to the plates of the 6F6's. As the meter remains in the circuit, it will show the current drawn by these tubes just as it indicates the current used by the 809's when the high power connections are made. These readings will, with the values given, be approximately as follows: 6F6's, static current 60 ma., peak current, 125 ma.; the 809's will have a static current of about 70 ma. and a peak current of 250 ma.

It was thought possible that in changing from low to high power that the primary taps of the output transformer would have to be adjusted. Fortunately this was not found to be necessary, as in both conditions the plate impedance came close enough to 9000 ohms to allow that set of taps, 1, 3-4, 6 to be used.

The simplified mechanical construction and electrical hookup of the dual-purpose jack which properly connects the input of the amplifier either for a crystal or for a single-button-carbon microphone.

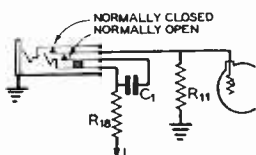

The plug for the crystal microphone is inserted only until it actuates the first spring. When it is desired to use a carbon mike, the plug is inserted until it actuates the second spring. The use of a specially constructed jack such as this eliminates the need for the two jacks and switch shown in the main schematic diagram.

The secondary tapping will be determined by your own particular combination of voltage and current, as supplied to your final r.f. stage. It is, as we all should know, imperative that the load be reasonably well matched, as a bad impedance match will do more than any other one thing to introduce distortion into what might otherwise be good modulation.

Circuit Considerations

I suggest that the reader refer to the original story¹ for more authoritative circuit information. The subject has been covered quite thoroughly.

An exception is in the input circuit, where additional provision has been made to allow the use of a single-button carbon microphone as well as the conventional crystal. Many amateurs find the well known type F1 single button to their liking and many others do not at present possess a crystal microphone, though they probably intend to acquire one sooner or later.

In the diagram you will note that two alternative methods of installing the input circuit have been shown. The one I have used employs a re-constructed type 6-706 Mallory-Yaxley long frame jack as combined input jack and switch. This was done to allow a more pleasing and less confusing front panel layout. The jack is mounted directly below the gain control, where there is no question as to its purpose. If one prefers to use two jacks and a selecting switch, the diagram is quite clear as to the method of connection of this input circuit.

The Alternative Carbon-Mike Input Circuit

It seems apparent that the average amateur does not understand how it is possible to

eliminate the usual and trouble producing mike-to-grid transformer and still use the time honored carbon microphone. Though it has been explained on numerous occasions, perhaps a resume of the subject may be welcomed by the readers.

Referring to the diagram, we find that the microphone circuit encompasses the microphone with its leads and jack, the leads from the jack to ground and to the lead resistor R_{10} . The bottom of this resistor is at ground potential with respect to audio voltages due to the by-pass condenser C_{12} . However, it is a few volts above ground with respect to d.c. which flows through the resistor and the microphone back to ground. The microphone bottom is, after all, merely a variable resistance whose value is changed by the movement of the diaphragm. This changing resistance causes more or less current to flow through the circuit and hence causes a corresponding voltage change to appear across the load resistor. At the high end of this load resistor we find the coupling condenser C_{11} which transfers these changes in voltage to the grid of the tube as audio voltages, and that's that.

The only difference between this type of coupling and the more common transformer coupling is that here we have to get along without the voltage step-up present in the impedance matching mike-to-grid transformer. The lack of this transformer brings the output of the carbon microphone down to practically the level of the average crystal microphone, which is quite convenient. The gain control will be operated in approximately the same position for either carbon mike or crystal microphone input.

Another change in the circuit is that the recommended bias cell has been omitted from the lineup, being replaced by a high value of input resistance. Both methods seem to be good practice, but I personally don't like to install bias cells. At least one never has to worry about the polarity of a resistor.

All other exceptions or changes in the circuit are minor ones, and as I have taken care to use the same symbols, numbers and letters in the parts list as were used in the original story, it is a simple matter to compare the two lists. Both will deliver satisfactory results.

Three additional refinements which follow good operating practice have been added to the original circuit. The first is the additional plate power pilot light whose connections will be noted on S_2 . The second is a monitor jack connected across the grids of the push pull 6F6's, and the third is tone

¹ R. L. Dawley "An Inexpensive 25-Watt Modulator," RADIO, Jan. 1939, p. 72.

Under-chassis view of the amplifier. The especially rebuilt input jack for different types of microphones is used in this model of the amplifier.

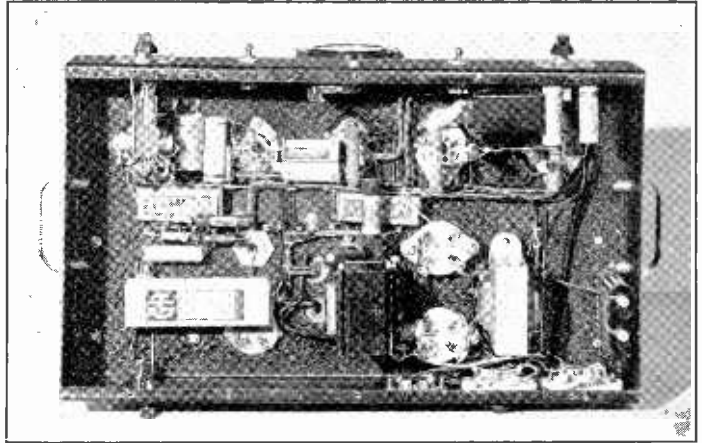

control, which combine in making better or at least more pleasing audio adjustments a matter under the control of the operator. Note carefully the necessity of insulating the monitor jack from the chassis. Both sides are above ground. If the tone control fails to meet with your approval I refer you to a recent issue of RADIO on the matter of reducing high frequency response.

Mechanical Layout

In planning new equipment, it is well to look to the future and make arrangements for some sort of standardization. On the basis of standard width panel construction, spacing of controls is in units of $3\frac{1}{4}$ inches each side of the center-line. Thus, with our meter on the center line of the panel, the two control dials fall two units each side of center, or $6\frac{1}{2}$ inches on each side, which will leave one unit on each side of a standard 19" panel.

Even though the finish of this job is a dust cover which fits over the standard 10" x 17" x 3" chassis, it is still a good idea to stick to standard spacing, even though the dials come closer to the edge than the standard unit.

This brings us back to the single, duo-purpose microphone jack. Considering the desirability of a symmetrical front panel layout the junk box was raided for a trick jack. Finding none available that did exactly what was wanted, a model 6-700 long frame Yaxley was taken apart and re-assembled as shown in the diagram.

In operation, the jack from the crystal microphone is inserted so that the tip is thrust under the first contact. Care must be taken that the tip does not also touch the

second contact. Adjust the second leaf so that it contacts the first tip contact when the jack is in place. This makes the circuit complete from the tip of the jack through the second leaf contact directly to the grid.

For the carbon microphone, push the jack all the way in, which will break the contact between the top leaf and the second leaf. The tip of the jack will lift the inner leaf and through the insulated push rod will lift the third leaf to contact the second. This couples the audio voltages developed across the load resistor to the grid, and at the same time complete the d.c. circuit through the microphone. After the adjustments are properly made it might be well to slip a collar or sleeve over the crystal microphone jack so it will not go in too far. Don't worry about the d.c. voltage ruining the microphone should the plug accidentally be pushed in too far. It will do no harm except to make the circuit inoperative.

It may be found that the voltage developed for the microphone by the bleeder circuit R_{16} and R_{17} may not be sufficient for your microphone. This voltage can be changed by changing the value of R_{17} . To increase the voltage, increase the resistance and vice versa. Do not increase the resistance to more than 450 ohms. Have the microphone checked if satisfactory results are not obtained below that figure.

Wiring

Because of the ample space available, little difficulty should be encountered in wiring. It is always well to study the layout of the under side of the chassis after mounting all

[Continued on Page 78]

SERIES CATHODE MODULATION

By RAY L. DAWLEY,* W6DHC

A description of a considerably simplified and less expensive system of cathode modulation requiring no transformers and eliminating the need for a power supply for the speech amplifier.

Conventional cathode modulation, its design and operation, has been covered in ample detail elsewhere in this issue. This other article covers the subject thoroughly enough so that a cathode modulated transmitter of any power rating and employing any tube complement can be designed by the simple application of the data and procedure given.

Series Modulation

A system of class A modulation using the modulator tube in series with the modulated amplifier is shown in figure 1. This system is called series plate modulation and is not commonly used because the modulator tube must be run straight class A, with consequent low plate efficiency, and because the plate supply voltage must be the sum of the modulator plate voltage and the voltage it is desired to run on the modulated amplifier. Also, the modulator tube must have a very great amount of plate resistance change with modulating voltage. Aside from these considerations the system operates in a very much similar manner to parallel constant-current

*Technical Editor, RADIO.

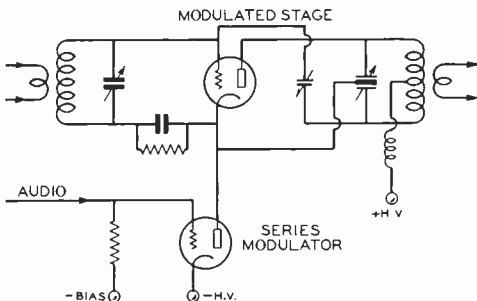

Figure 1. Simplified schematic of series plate modulation.

modulation (commonly called the *Heising* system).

However, if the grid return of the modulated stage is made to ground instead of to the cathode circuit of the modulated amplifier, we have the basis of a system of cathode modulation which has many inherent advantages.

Series Cathode Modulation

We shall call this system *series* cathode modulation to differentiate it both from conventional series modulation and from previous systems of cathode modulation. In series plate modulation the voltage drop across the modulator tube must be about one third greater than the drop across the modulated amplifier because the drop across the modulator cannot go quite to zero or quite to twice normal, while the drop across the modulated amplifier must be made to do this. However, for cathode modulation of an amplifier the a.c. voltage required in the cathode circuit is very much less than would be needed for plate modulation of the same amplifier. It has been found that any conventional amplifier (up to 1 kilowatt) will require from 100 to 300 peak volts in the cathode circuit for complete modulation. To get this amount of swing across the modulator tubes, from approximately 175 to 450 volts drop will be required, the drop being the effective "plate voltage" on the modulators.

It will immediately be noticed by reference to figure 2 that the voltage drop across the cathode modulator tube appears as grid bias on the modulated amplifier. This means that we have automatic cathode bias on the stage, equal to the drop across the series cathode tube. Experience has shown that when the proper drop across the series cathode tube for the production of the desired amount of audio modulating voltage has been determined,

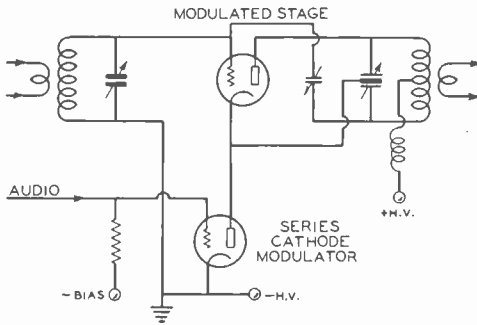

Figure 2. The grid return for the modulated stage is connected to ground instead of to the cathode to make series cathode modulation from series plate modulation.

Modulated Stage Design Considerations

All the factors entering into the design of the series cathode modulated amplifier will be similar to those for a cathode modulated amplifier of the conventional type. These factors have been covered in detail elsewhere in this issue. The main differences will lie in the fact that no grid leak is required, the grid return going directly to ground, and that the plate voltage supply must be greater than the calculated value by the amount of the drop across the series modulator. This value, as mentioned before, will lie between 175 and 450 volts depending upon the modulated tubes, and upon their plate voltage and other operating conditions.

The Series Cathode Modulator

It is in the design of the series modulator that the majority of the problems associated with this system of modulation lie. Hence the design of a typical modulator will be covered in some detail. When the modulator has been properly designed it will only be necessary to insert it in series with the cathode return of the stage to be modulated. The only external supply for the modulator will be a source of heater energy; the plate supply for the speech stages as well as the actual series modulator tubes comes from the voltage drop in the cathode circuit of the modu-

this value of cathode drop will be a satisfactory amount of d.c. grid bias for the modulated stage. No additional grid-leak or power-supply bias will be required. This has been found to hold true for all triodes with an amplification factor of from 15 to 35.

With practically all medium and high μ tubes, no provision for limiting the plate current of the amplifier in cases of excitation failure need be made; the resistance of the series modulator will be ample to limit the plate current to a safe value.

Figure 3. A push-pull amplifier using a pair of 810's which was series cathode modulated at a total plate supply voltage of 2400 volts to give a measured carrier output of 360 watts on the 14-Mc. band. Tests show that 254's, 100TH's, or TW-150's can be substituted for the 810's with very little change in the operation.

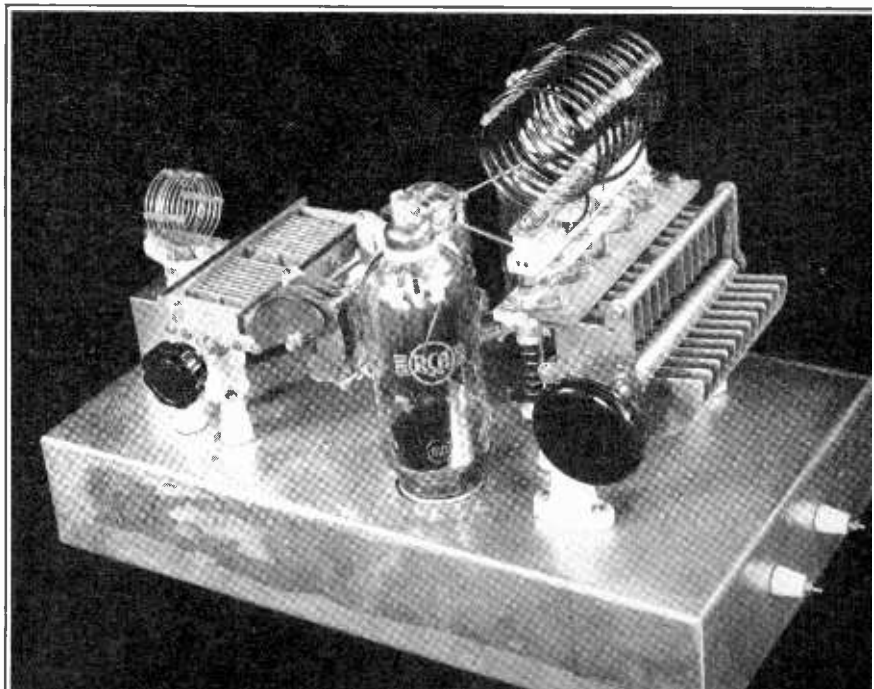

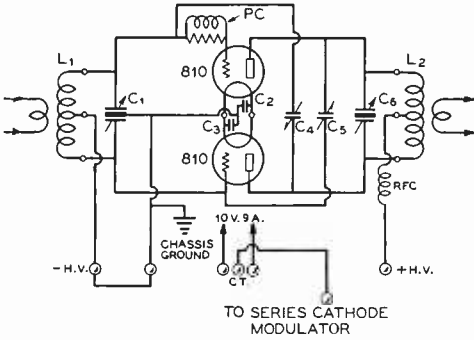

Figure 4. Wiring diagram of the 810 amplifier showing connections for series cathode modulation. To operate the amplifier it is only necessary to remove the jumper from the grid return to ground and insert a source of grid bias, and to connect the filament c.t. to ground.

- C₁—100- μ fd. per section, 3000 v. spacing
- C₂, C₃—0.02 - μ fd. 1000 volts mica
- C₄, C₅—4 - 9 - μ fd. neut. condensers
- C₆—50 - μ fd. per section, 6000 v. spacing.
- L₁ — Manufactured
- 50-w. plug-in coil for desired band with center link
- L₂ — Manufactured 500-w. plug-in coil for desired band with center link.
- PC — Manufactured parasitic choke
- RFC—2½-mh., 500-ma. choke

lated stage. It is in this manner that the need for a speech amplifier power supply is eliminated.

Specific Design of a Modulator

Suppose the push-pull 810 amplifier illustrated in figure 3 and diagrammed in figure 4 is to be series cathode modulated under the maximum conditions consistent with the ICAS ratings on the tube. The maximum plate dissipation for the two tubes is 300 watts. Multiplying this value by the factor 2.2 (see other article) we determine that the input at which the tubes will be operated is 660 watts. They will operate at an efficiency of approximately 55 per cent, which means that about 360 watts of carrier output will be obtained and that the other 300 watts will be dissipated by the plates of the tubes. From the information given in that article we see that about 33 watts of excitation power will be needed (5 per cent of the plate input). It is desired to operate the tubes at an actual plate-to-cathode voltage of 2000 volts; hence the plate current taken by the tubes will be 330 ma. to give 660 watts input.

Now it is immediately apparent by ref-

erence to figure 2 that the total plate current of the modulated stage *plus* the grid current of the stage must pass through the modulator. About 40 ma. of grid current will flow when proper excitation is had, which means that the total cathode current to the 810's will be about 370 ma. Experience has shown that conventional tubes operating under full excitation and at maximum output conditions will require a cathode swing of from 10 to 15 per cent of the plate voltage. To obtain a peak cathode swing of 300 volts (15 per cent of 2000 volts) we will require about 400 volts drop across the series cathode modulator. Hence our total plate supply voltage for the modulated stage and the series cathode modulator will be 2400 volts.

After considerable experimentation in evaluating different designs it was determined that beam tetrodes operating with shunt degenerative feedback made by far the most satisfactory series cathode modulator. Where the cathode drop is to be 175 to 250 volts the 6Y6G tube will be found to be best; each 6Y6G will handle about 70 ma. For cathode drop voltages from 250 to 450 the 6L6 is most satisfactory and each 6L6 will handle about 90 ma. of plate current up to 400 volts; above 400 volts the permissible plate current should be reduced to 75 ma.

In determining the required tube complement for the cathode modulator it must be remembered that the current requirements of the speech tubes and the screens of the series modulators must be taken into consideration. This value will vary from about 14 ma. with the speech amplifier shown and one 6L6 or 6Y6G to about 30 ma. when four 6L6's are used.

Since we have determined that the cathode current to the 810's will be about 370 ma. and since we know that our speech amplifier weighting current will be about 30 ma., this leaves about 340 ma. that must be handled by the series tubes at about 400 volts drop. Four 6L6's will handle this current.

The series cathode modulator itself is diagrammed in figure 5 and shown in figure 6. It employs a 6SJ7 high-gain amplifier out of a crystal mike into another 6SJ7 connected as an inverse-feedback stage in conjunction with the output tubes. The values shown for the first two stages of this speech amplifier are universal and should be used whether the modulator consists of a single 6Y6G or 6L6 or a number of either type in parallel.

As was determined by the necessary current handling ability and cathode drop, the output stage consists of four 6L6's in parallel. 100-ohm resistors are connected in series

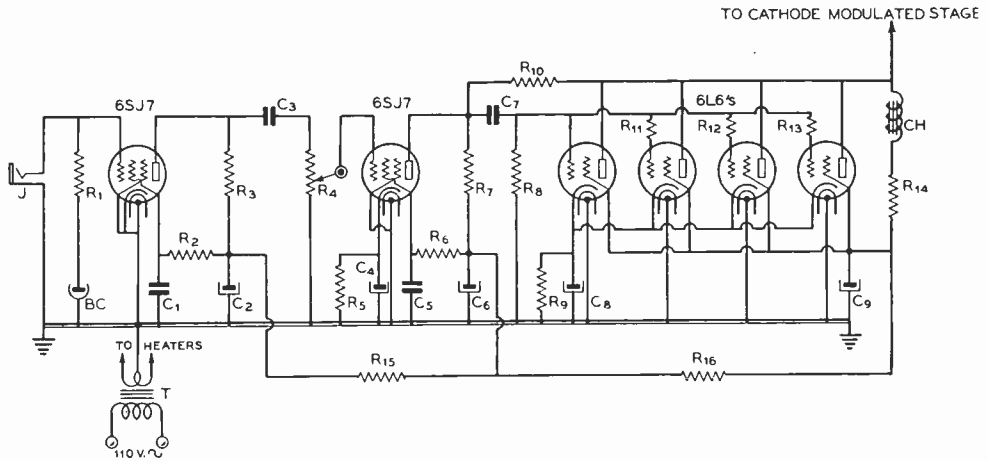

Figure 5. Wiring diagram of the series cathode modulator using four paralleled 6L6's in the output. The first two stages of speech up to and including R₁₀ and R₁ would remain the same for different output stages.

- | | | | |
|----------------------------------------------------|----------------------------------------------|-----------------------------------------|--------------------------------------|
| C ₁ —0.25- μ fd. 600-volt tubular | C ₅ —50- μ fd. 50-volt elect. | R ₇ —500 ohms, 1 watt | R ₁₃ —2500 ohms, 10 watts |
| C ₂ —8- μ fd. 450-volt electrolytic | C ₆ —8- μ fd. 450-volt elect. | R ₈ —500,000 ohms, 1/2 watt | R ₁₅ —10,000 ohms, 1 watt |
| C ₃ —.02- μ fd. 400-volt tubular | R ₁ —1 megohm, 1/2 watt | R ₉ —100,000 ohms, 1 watt | R ₁₆ —10,000 ohms, 1 watt |
| C ₄ —10- μ fd. 25-volt tubular | R ₂ —500,000 ohms, 1/2 watt | R ₁₀ —100,000 ohms, 1/2 watt | T—6.3-volt 6-amp. filament trans. |
| C ₇ —0.1- μ fd. 600-volt tubular | R ₃ —250,000 ohms, 1/2 watt | R ₁₁ —50 ohms, 10 watts | CH—10-hy. 65-ma. filter choke |
| C ₈ —8- μ fd. 450-volt elect. | R ₄ —500,000-ohm potentiometer | R ₁₂ —500,000 ohms, 1/2 watt | J—Crystal mike jack |
| C ₉ —.05- μ fd. 400-volt tubular | | R ₁₃ —100 ohms, 1 watt | BC—Bias cell |

with the grids of the various tubes to kill any chance for a parasitic to develop in the four paralleled tubes. Parasitic suppressor resistors should always be used when two or more tubes are used in the output stage.

As will be seen from figure 5 the supply voltage for the screens of the output tubes and for the plates and screens of the low-level stages is taken from the plates of the output tubes by means of a choke input filter system. This filter supplies well filtered d.c., free from any audio component, to the low-level plates and screens. In other words, the audio component appearing at the plates of the series modulator tubes (which cathode modulates the r.f. amplifier) is isolated from the d.c. component to give a supply of pure direct plate voltage for the low-level stages.

Cathode bias is used on the 6L6's since the additional 20 volts or so required for grid bias of these tubes will be insignificant compared to the plate voltage.

The Inverse Feedback Circuit

Degenerative feedback can offer many

worthwhile advantages by its incorporation into a system of this kind. In the first place, the harmonic distortion of single-ended 6L6's operating without inverse feedback is comparatively high. In the second place, the plate resistance of 6L6's (even though a number of them are paralleled) is quite high. The incorporation of the simple inverse feedback system shown reduces the distortion of the modulator to about one fourth the value without feedback. In addition the dynamic plate resistance of the paralleled tubes is reduced to about 400 ohms—just about the correct value for cathode modulation of an amplifier of the type shown.

The approximately 6 db of degenerative feedback between the plates of the 6L6's and their input circuit is obtained through the simple expedient of placing a 500,000-ohm resistor between the plate of the second 6SJ7 and the plates of the paralleled modulators. It is necessary to use a tube with a high plate impedance as the second speech stage in order for the feedback circuit to operate satisfactorily. No changes need be made in this

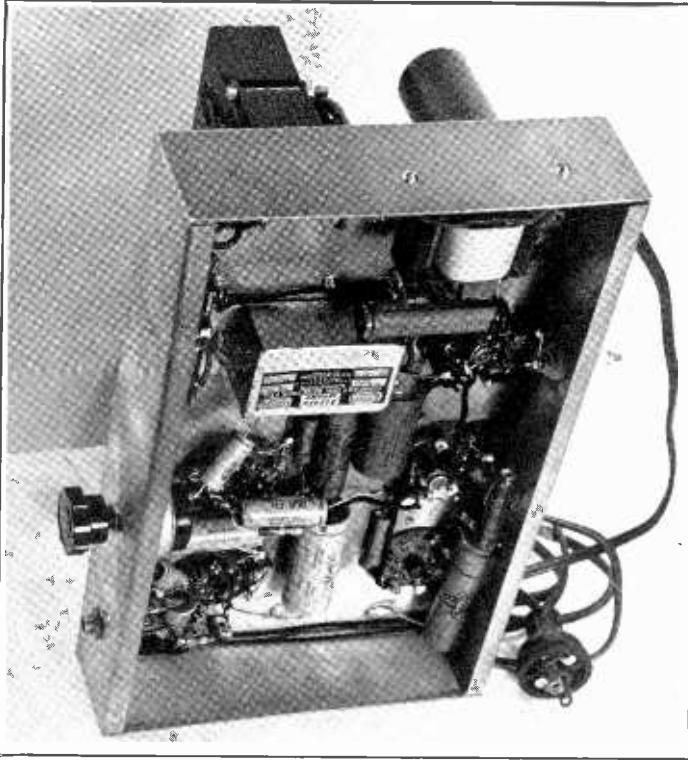

Figure 6. Bottom view of the four-6L6 series cathode modulator.

or in the preceding stage of the speech amplifier for operation into various numbers of 6Y6G's or 6L6's.

The use of the degenerative feedback in the cathode circuit of the modulated amplifier will also greatly reduce harmonic distortion produced as a result of the cathode modulation of the stage. This is true because the distortion components accompanying modulation will appear in the cathode circuit and hence will be reduced by the feedback. In other words this makes a simple method of approximating the inclusion of any distortion characteristics of the modulated stage within the feedback loop.

Tuning Up and Operation

The tuning up of a series cathode modulated stage is very similar to the procedure employed in any cathode modulated amplifier—or for that matter for any efficiency modulated amplifier. The antenna loading must be comparatively high; the out-of-resonance plate current to the stage should be only about 20 per cent higher than the plate current at resonance. The excitation required

will usually be slightly less than would be required for a c.w. amplifier for the same power input.

From this point on it is best to have a cathode-ray oscilloscope to finish the tuning up process. Of course the amplifier may be tuned up to operate quite satisfactorily without the help of a 'scope but such an instrument is certainly a help in familiarizing oneself with the tuning procedure the first time. As is the case with all phone transmitters, regardless of the type of modulation, an oscilloscope will allow the tuning adjustments to be made more exactly. Oscillographic studies of the trapezoidal pattern and of the modulated wave of the 810 amplifier and modulator shown herewith showed that 100 per cent modulation with very good linearity was obtainable at 55 per cent efficiency with no great difficulty—at 60 per cent efficiency if carefully adjusted.

As a final warning, be sure that the filaments of the series modulator have been turned on before applying either excitation or plate voltage to the modulated stage. If this

[Continued on Page 78]

THE "ONE SIXTY"

A VARIABLE FREQUENCY EXCITER
FOR 160 METER PHONE

By W. W. SMITH,* W6BCX

The various "e.c." exciter that have been described recently have ignored the 160-meter phone man. His need for variable frequency control is just as great as that of amateurs working on higher frequency bands. The unit described here may be built for about \$8.00, may be added to most any existing 75- or 160-meter phone rig. At slight additional cost, it may be modified for use on higher frequencies.

In the last year the variable frequency type of exciter has become popular. Practically all of the exciters of this type that have been described have two things in common: (1) They are called "e.c." oscillators or exciters regardless of whether they are actually electron coupled or not. (2) They will not permit 160-meter operation.

There is no reason the 160-meter phone man should be left out in the cold. In fact, a variable frequency exciter for 160-meter operation can be constructed less expensively than one for use on the higher frequency bands, because there are no drastic voltage swoops and dives in a phone transmitter. No voltage regulation is required as is the case with a variable frequency exciter driving a high power c.w. transmitter.

Illustrated in figures 1 and 2, and diagrammed in figures 3 and 4, is a simple yet highly effective variable frequency exciter designed primarily for 160- and 75-meter phone operation. It can also be used on c.w. or on higher frequency bands if modified as will be described. When specifications are followed carefully, there will be no discernible frequency modulation or drift.

In an attempt to simplify the unit to the nth degree, the unit was first constructed with simply a 6J5 high-C oscillator running at 300 volts on 320 meters. Because of the excellent isolation provided by the existing crystal oscillator when used as a doubler to 160 meters, the stability was sufficiently good. However, a check revealed that even with careful shield-

ing the 320-m. oscillator was radiating an R9 carrier in the broadcast band over a radius of several hundred yards. 160-meter phone men already have enough grief trying to keep from stepping on the toes of h.c.l.'s; so it was decided that it would be advisable to get the oscillator out of the broadcast band.

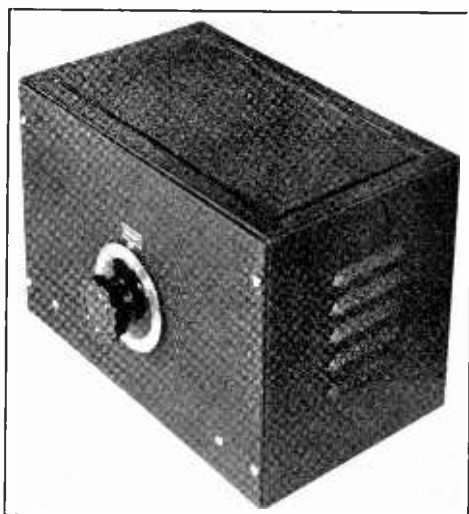

Figure 1.

The "One-Sixty", a variable frequency exciter that can be added to any conventional 160- or 75-meter phone rig. When driven by the One-Sixty, the existing crystal oscillator becomes either an unneutralized buffer-amplifier or a doubler, depending upon whether 160- or 75-meter output is desired.

* Editor, RADIO.



Figure 2.

Rear view of the One-Sixty with shield cabinet removed. The 6F6 is mounted as far as possible from the tank coil and the output terminal is placed near the 6F6 to permit a short plate lead. A hole is drilled in the rear of the cabinet to take the power plug. The cabinet should be well ventilated. Observe that both variable condensers are insulated from the chassis and that the smaller (tuning) condenser is driven by an insulated coupling. Resistors, fixed condensers, and the r.f. choke are mounted underneath the chassis.

When the oscillator was moved to 160 meters, the stability was not so good, because the driven stage (originally the crystal oscillator) was then working "straight through" and did not provide as good isolation of the self-excited oscillator. Also, it necessitated the addition of neutralization to the "ex" crystal oscillator. To get around the latter requirement and at the same time provide a high degree of isolation of the oscillator, an untuned buffer stage was added. As this stage requires only an inexpensive tube, a socket, an r.f. choke, and a grid leak, it does not add appreciably to the total cost of the unit.

Because the untuned buffer requires negligible excitation power, the oscillator voltage was dropped to 200 volts. The oscillator tank is high "C" and very lightly loaded; it has high Q and provides excellent stability.

Construction

Construction of the "One Sixty" presents no difficult problems and entails no great amount of labor. The unit is built on a $5\frac{1}{2} \times 9 \times 1\frac{1}{2}$ inch chassis which supports a 7 x 10 inch panel. A ventilated cabinet is required to shield the oscillator from stray pickup and at the same time permit free circulation of air. The tubes, especially the 6F6, are placed as far as possible from the oscillator tank coil to minimize frequency drift due to heating of the coil.

Both rotor and stator of both the tuning condenser and the padding condenser are "hot" with r.f. Hence both of these condensers must be insulated from the chassis. The padding condenser (a standard b.c. type condenser) is mounted on end to facilitate adjustment and minimize the possibility of the rotor being jarred sufficiently to affect calibration of the tuning condenser. When this condenser is mounted as shown, the cabinet may be hit a heavy blow without danger of the padder capacity being affected. This condenser should have its mica trimmer removed before it is mounted rigidly as illustrated by means of standoff insulators and brackets.

The tuning condenser is mounted by means of a special bracket supplied by the manufacturer (it fastens to the ceramic portion of the condenser) and is driven by means of an insulated shaft coupling and a piece of brass or steel shafting. A midget single-circuit jack is used for a panel bearing, as the tension of the jack on the shaft is a desirable feature when a non-vernier type dial is used. With an ordinary bearing the dial actually turns too easily.

The Oscillator Coil

The tank coil is wound on a standard $1\frac{1}{2}$ inch form. It consists of 24 turns of no. 20 d.c.c. "loosely close wound" and tapped at the exact center and one quarter of the way

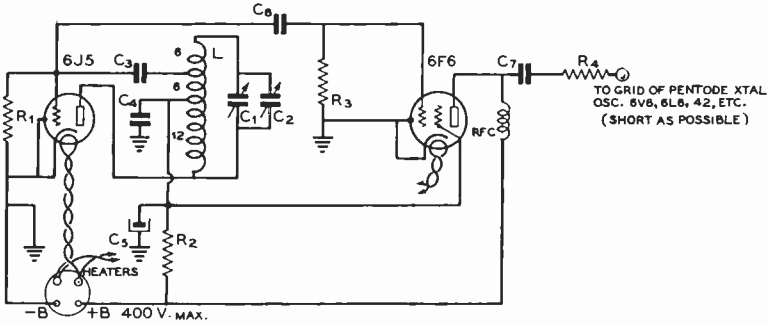

Figure 3.
Wiring Diagram of the One-Sixty.

- C₁—100-μfd. midget condenser of good quality (tuning condenser) insulated from chassis and driven by insulated coupling
- C₂—365 or 375-μfd. broadcast type condenser with mica trimmer removed,

- insulated from chassis (padding condenser)
- C₃—100-μfd. midget mica condenser
- C₄—.05-μfd. 400 v. tubular
- C₅—8-μfd. tubular type 450 v. midget electrolytic or VR-

- 150-30 voltage regulator tube (see text)
- C₆—100-μfd. midget mica condenser
- C₇—.001-μfd. midget mica condenser
- R₁—100,000 ohms, 1 watt carbon
- R₂—20,000 ohms, 10 watts

- R₃—150,000 ohms, 1 watt carbon
- R₄—100 ohms, 1/2 watt carbon
- RFC—2.5 mh. r.f. choke
- L—See text
- Note:—Be sure to use metal tubes and ground shell

from one end. Thus the coil is tapped at the 12th turn for the ground return and at the 6th turn from the center (or from the "free" end) for the grid connection. These should be actual *taps*; in other words, the wire should not be made to run to a prong and then back through the same hole in the form. The turns are spaced so that with C₂ set at maximum capacity the tuning condenser C₁ hits 2000 kc. with the plates all the way out. The turns are then cemented firmly in place with three ridges of coil dope the length of the winding. Make sure there are no shorted turns where the taps are made. C₂ is then reduced slightly from maximum capacity until the band of 1800 to 2000 kc. is centered on the dial. There will be a few degrees to spare on either end of the dial when this is done.

The output of the untuned 6F6 stages depends almost entirely upon the amount of stray shunt capacity across the load. Therefore, the lead from the plate of the 6F6 to the grid of the regular crystal oscillator should be made as short as possible. There will still be sufficient drive if the lead is as long as two feet, but it is desirable to make the lead shorter if possible. The output connection of the One-Sixty is placed out the rear of the chassis as close as possible to the 6F6. If it will permit a shorter lead from

the One-Sixty output terminal to the crystal oscillator grid, the whole layout of the One-Sixty may be transposed, putting the output terminal at the other end of the chassis.

Someone is sure to wail because the short lead requirement makes it impossible for the unit to be placed on the operating desk several feet from the transmitter proper. However, as it is necessary to retune an entire transmitter on 160 meters when moving more than 10 kc., there is no advantage in having the One-Sixty on the operating desk. It is true that practically the whole 20-meter phone band can be covered without retuning a transmitter; but on 160 meters a shift from one end of the phone band to the other represents a change of about 10 per cent, not 0.7 of 1 per cent as it does on 20 meters. If the unit is to be used on 20 meters and it is desired to place the unit on the operating table, simply include as part of the One-Sixty the unit of figure 4 and link couple to the transmitter.

All r.f. leads in the One-Sixty are of no. 14 bus wire to prevent vibration. Other leads are of ordinary push-back hook up wire.

Operation

Figure 4 shows how the existing crystal oscillator is modified so as to permit operation either as a straight crystal oscillator or as an

unneutralized buffer-amplifier or doubler. Except for the use of grid leak bias, the circuit is no doubt the same as used in perhaps 90 per cent of the transmitters in use.

The switch S_1 should have low capacity to ground, and the lead from S_1 to the output terminal of the One-Sixty should not only be short but should be kept away from metal panels and chassis by at least an inch. The more capacity this lead has to ground, the less the excitation delivered.

The plate current drawn by the One-Sixty in milliamperes will be one tenth the plate voltage in volts. Thus, at 400 volts (the maximum permissible voltage) the total plate current is about 40 ma. Ordinarily this amount of current may be "robbed" from the same supply that feeds the crystal oscillator without overheating of the power pack. If not, a small pack suitable for the purpose may be constructed from a midget b.c.l. transformer, an 80, a 50 ma. filter choke, and a dual 8- μ fd. electrolytic condenser. Such a pack can be built for about \$4.00 and will deliver approximately 375 volts at a 35-40 ma. load. If an individual power supply of this type is used for the One-Sixty, the heaters of the tubes in the One-Sixty should be supplied from the transformer that supplies the other 6.3 volt tubes in the transmitter. In any case the One-Sixty chassis or B minus should be connected to the common ground of the transmitter.

If the One-Sixty derives its plate voltage from the crystal oscillator supply, some provision should be made for switching on the One-Sixty independently to permit "spotting" of the frequency on the receiver. This can be done by incorporating a switch connected as S_2 in figure 4. By throwing the switch it is possible to apply voltage to the One-Sixty without turning on the transmitter. The additional drain will not be sufficient to harm the receiver power supply. If the signal in the receiver is too strong for accurate frequency determination, the strength may be reduced by increasing the value of the resistor in the lead from the receiver plate voltage to switch S_2 . Switch S_2 most conveniently may be placed at the operating position. When full voltage is applied to the One-Sixty the frequency will shift slightly; but as it is only a matter of a couple of hundred cycles at most, you can assume that your frequency is exactly as you hear it in your receiver.

One or two warnings are in order. Do not attempt to spot yourself accurately on your receiver by means of the beat oscillator, as it is possible to go astray by a couple of kc. when the beat oscillator is set for "offset"

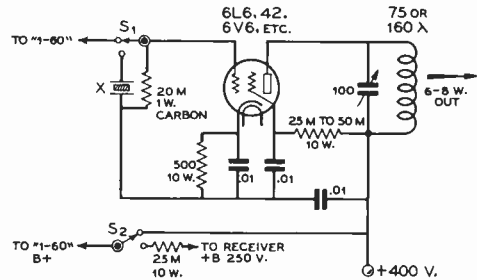

Figure 4.

Showing how an existing 160-meter crystal oscillator is arranged for optional crystal control or "One Sixty" excitation. If the oscillator has an r.f. choke across the crystal instead of a grid leak, it should be removed and a 20,000-ohm carbon resistor substituted as illustrated in the diagram. No r.f. choke should be used in the B plus lead to the crystal oscillator or a low frequency parasitic may result when S_1 is thrown to the "One Sixty" position. The lead from S_1 to the output terminal of the "One Sixty" unit preferably should not be over 12 inches long. S_2 permits "spotting" the frequency without turning on the transmitter, and should have good insulation. The One-Sixty may be placed on the operating desk if the above unit is incorporated in the same cabinet, in which case link coupling would be used to the transmitter.

tuning of c.w. signals. Do not attempt to operate closer than 10 kc. to the edge of the band with the One-Sixty. If you want to work closer than this (and you really shouldn't try to work *very* much closer on phone) it is recommended that you use a crystal. If the unit is placed where it will be subjected to jars or vibration, it should be mounted on sponge rubber "feet."

C.W. or High Frequency Phone

While the exciter was designed primarily for 160-meter operation, results on higher frequencies are substantially as good because of the better isolation of the self-excited oscillator when one or more frequency doublers are used. Without a voltage regulator tube, the exciter is not recommended for use on c.w. or above 4000 kc. on phone. If c.w. work or high frequency phone operation is desired, a type VR-150-30 voltage regulator tube should be substituted for C_s in figure 3. The voltage regulator will not work correctly unless the plate voltage on the One-Sixty is at least 375 volts.

A regulator tube is also desirable on 75- and 160-meter phone if a high power class B modulator is used and the primary regulation is not good; in other words if the line

[Continued on Page 76]

REDUCING SPLATTER

in Phone Transmitters

By RAY L. DAWLEY,* W6DHC

There are frequent cases where it has been found impossible to remove completely the splatter accompanying the modulation of a phone transmitter by any of the ordinary means. Another transmitter with the same tube lineup but with a slightly different physical layout will be capable of substantially complete modulation without any trace of splatter while the offending transmitter will begin to have spurious sidebands long before 100 per cent modulation has been reached.

When the operator of such a transmitter was conscientious he would probably attempt to isolate the trouble for a couple of sleepless nights, then finally give up and try rebuilding various stages of the transmitter until finally he found that the trouble has disappeared. Were he not quite so conscientious he probably would just forget about it (as many have done) and let the other fellow on the band do the worrying.

Amplitude and Phase Modulation

In many cases of this kind, after every other avenue of attack has failed, it is quite possible that the difficulty may be found to lie in a seldom thought of type of modulation, phase modulation of the output of the transmitter. Phase modulation of limited amplitude in itself will cause no spurious sidebands; neither will conventional amplitude modulation. However, since the phase modulation that is taking place is the result of amplitude modulation, both modulation types are appearing at the same time with the result that new second and higher order sidebands are produced. It is these new higher order sidebands that cause adjacent channel splatter.

Phase modulation can be explained as a variation in the instantaneous phase of the carrier wave with respect to the phase that the

carrier would have at this instant were it not modulated, this variation taking place at an audio rate. Audio modulation of one polarity will cause a slight acceleration in the angular velocity of a vector which can be thought of as representing the carrier frequency; modulation of the opposite polarity will cause a deceleration in the velocity of the vector and under carrier conditions the angular velocity of the carrier vector would be constant. If the maximum phase shift or instantaneous vector displacement is one radian (57.3°) or less the sideband components produced in the output of a phase (only) modulated transmitter will be substantially the same as those produced in the output of a conventional amplitude modulated transmitter; the output wave will consist of first order sideband components in addition to the carrier. In other words only the ordinary sum and difference frequencies will appear. However, if the maximum angle of displacement due to modulation is more than one radian, second and higher order components similar to those produced by overmodulation of an amplitude modulated transmitter will appear in the output.

So we see that if phase modulation in excess of one radian is taking place at *any* modulation percentage as far as amplitude modulation is concerned, the resulting effect will be the same as though the transmitter were being amplitude modulated in excess of 100 per cent. Actually the transmitter *is* being modulated in excess of its modulation capability as soon as higher than first order effects due either to amplitude or to phase modulation appear as sidebands in the output. As a matter of fact, as long as *any* phase modulation is taking place along with the desired amplitude modulation, second order effects or double-modulation-frequency sidebands will appear in the output. Then if the transmitter is being phase modulated in excess of one radian the spurious-sideband

* Technical Editor, RADIO.

condition can be really serious due to sidebands of three, four, or five times the modulation frequency.

By another analysis of phase modulation it can be shown that the result is identical to frequency modulation but with a very limited change in the frequency of the transmitter due to modulation. Since the carrier vector is being accelerated and decelerated with modulation it can be seen that at any point on the modulation cycle the instantaneous output frequency of the transmitter is different from what it is under carrier conditions.

Causes of Undesired Phase Modulation

There are three conditions that may exist in a phone transmitter which can cause phase modulation. The first is regeneration in the final stage caused by its being operated out of neutralization. The magnitude of phase modulation will be proportional to the amount the stage is out of neutralization and to the transconductance of the tubes. If the final amplifier is exactly neutralized no phase modulation can arise from this source. However, the amplifier may appear to be neutralized when it is tuned up without plate voltage and yet when plate voltage is applied it may show signs of regeneration or degeneration. This condition is much more likely to appear in a single-ended stage when operating at a high carrier frequency than in a push-pull stage.

Operation Into Reactive Load

Another condition which can easily cause phase modulation is the operation of the modulated stage into a reactive load. This can occur when the final tank circuit is simply detuned from resonance for one reason or another. In such a case the tubes would not be operating at minimum plate current and restoring the tank to resonance would correct the difficulty. Phase modulation arising from this condition is the result of variations in the plate resistance of the tubes with modulation acting in series with the reactance of the output circuit.

The final stage may also be operating into a reactive load when the final tank is tightly coupled to an antenna system which is not exactly at resonance. When coupling an antenna system to a transmitter makes it necessary to retune the plate tank for minimum plate current it is more than likely that the tubes are operating into some reactance. If the tank is comparatively high Q it is possible that the reactance will be small and will cause no ill effects. However, if the tank circuit is of the minimum Q permissible for

the operation of the stage into a resistive load it is quite possible that when the tank is retuned to minimum plate current it is really being retuned to maximum tank *impedance* and not necessarily to tank resonance. Under these conditions the tubes would be operating into a reactance (more than likely an inductive reactance) when the tank has been retuned to minimum plate current. Such a condition will cause phase modulation along with the desired amplitude modulation.

An arrangement which can very easily cause phase modulation is the operation of a modulated amplifier into a pi network, especially one of the so-called simplified type where the tank circuit has been eliminated and the tube operates directly into the first condenser of the network. If the network has not been accurately designed, or if the stage is not being operated very closely in accordance with the design, it is quite easy to have a condition which will cause phase modulation.

Testing for Reactive Load on the Final

Since the operation of the modulated stage into a reactive load can so easily cause phase modulation with its attendant undesirable effects, a test which would tell whether or not the stage were operating into such a load would be of assistance. When an amplifier has been properly neutralized and has no regeneration or degeneration in the stage, the point of minimum plate current will exactly coincide with the setting of the final amplifier tank condenser which gives maximum grid current. This should be true with the amplifier both loaded and unloaded.

It is of course true that the grid current to the stage will be less with plate voltage on the tubes than before the voltage was applied. It is also common knowledge that as the plate tank condenser is detuned either side of resonance the plate current will increase and the grid current will decrease still further. The important thing is that the grid current be highest exactly at the same point that the plate current is lowest. In any amplifier that is operating correctly this will be the case. But when an amplifier is being loaded too heavily for a low-Q plate tank or when a reactance is being coupled into its plate circuit from an external source maximum grid current will not flow at the point of minimum plate current. When a stage in which the two points do not coincide is modulated, phase modulation to a greater or lesser extent will take place, the amount of such modulation being dependent upon the

[Continued on Page 77]

FREQUENCY MEASUREMENT

on the Ultra Highs

By KEITH J. HAYES,* W9ZGD

While trying to get some of the local boys down on 112 Mc., I found that few of them had any idea how to find the band. Those who had five-meter equipment managed pretty well by using second harmonics from it, but most of those who are getting interested in the ultra highs at the present time do not have five-meter oscillators. Crystal-controlled rigs are no good for this purpose as they have too many extra harmonics from the low-frequency stages. The purpose of this article is to give a few ideas to those who are interested in checking frequencies of operation that are higher than those for which their measuring equipment is calibrated.

The first thing one considers is usually a system of lecher wires. Contrary to general belief, they cannot be relied on for more than a very approximate check. True, if they are used very carefully and with the right correction factor, they will give fairly good results, but the trouble is seldom justified. However, they are useful as absorption wavemeters for getting the right harmonic.

A high-frequency superhet provides a good frequency check because the harmonics from its h.f. oscillator beat with ultra-high-frequency signals and produce beat signals at the intermediate frequency. The harmonics can also be used as signals or known frequency for calibrating receivers.

If a ten-meter superhet is tuned across the band while an oscillator is running in the same room on 112 Mc., two signals from the oscillator will be heard—one with the dial at 27,430 kc. and the other at 27,658 kc. (assuming a 456-kc. i.f.). No, it's not a "sub-harmonic," it's simply the fourth harmonic of the receiver's h.f. oscillator on 111,544 kc. and 112,456 kc. beating with the 112-Mc. signal to produce the 456-kc. signal for the i.f. channel. The r.f. and detector

stages aren't tuned to 112 Mc. but the signal from the 112-Mc. oscillator is strong enough to blast right through the ten-meter circuits.

The exact frequency of any u.h.f. oscillator may easily be determined by the formula

$$F = k(df + if) - if$$

in which k is the order of the harmonic, df is the frequency indicated by the receiver (using the higher frequency of the two signals), and if is the intermediate frequency. Substituting for the case in the preceding paragraph we get

$$F = 4(27,658 + 456) - 456 = 112 \text{ Mc.}$$

If the oscillator of the superhet happens to be on the low side of the signal frequency, as it may be in a homebuilt receiver, the plus sign should be changed to minus. The appropriate value for k may be determined by lecher wires, or by observing the number of dial divisions between the image and the fundamental. When using the second harmonic of the h.f. oscillator, they will be half as far apart as with the fundamental; when using the fourth harmonic they will be one fourth as far apart, etc.

To use the harmonics of the h.f. oscillator as a signal generator, it is only necessary to remember that the h.f. oscillator is on a frequency 456 kc. (or whatever your intermediate frequency is) higher than that indicated by the dial. If the images on your receiver come in on a lower frequency than the fundamental, it is one of the rare cases where the oscillator is lower in frequency than the detector, and the i.f. should be subtracted from, rather than added to, the dial frequency.

When using the superhet to calibrate an u.h.f. receiver, the harmonic in use can be determined by letting the u.h.f. receiver set while the superhet is tuned to a number of consecutive frequencies which put harmonics into the u.h.f. receiver. For instance you might

*4614 No. Sixth St., Milwaukee, Wis.

[Continued on Page 86]

"PIDGEE"

By W. A. WOEH, * W9WOP

A description of a self-contained and AC-operated phone and C.W. transmitter that lends itself to easy portability.

Pidgee began life as an idea. Although it was somewhat vague at first, it gradually developed on paper and workbench into the final attainment of an honest-to-goodness successful midget transmitter. Pidgee is very small and compact, scaling off at 7" x 10" x 8", and is entirely self-contained except for the mike or key and the antenna.

Week-ends in the country brought forth the desirability of an easily portable transmitter; something that could be stowed behind the car seat and that wouldn't need a box full of accessories to set it up at the desired location. Phone and c.w. operation as well as all band coverage from 160 to 10 meters were desired, yet simplicity and low cost were the guiding factors. Pidgee accomplishes all these with sufficient power out-

put to give enjoyable contacts on all bands. No costly meters are used or are necessary. On phone, a single-button mike is used; in our case it happens to be the "bottom end" of a telephone handset. Modulation quality and percentage are good, while on c.w. T9X reports are common. So much for the build up, now for the "inside dope."

The schematic diagram just about tells the whole story. A 6V6G crystal oscillator is used to excite a 6V6G r.f. amplifier. This amplifier is either keyed for c.w. or modulated by another 6V6G for phone work. An ordinary replacement power transformer such as is commonly used in a six-tube radio together with an 80 rectifier are used in the power pack. As shown in the photo, this transformer is mounted at the right rear of the chassis using long bolts and spacers. This leaves space underneath the chassis

* 1927 S. Grove, Berwyn, Illinois.

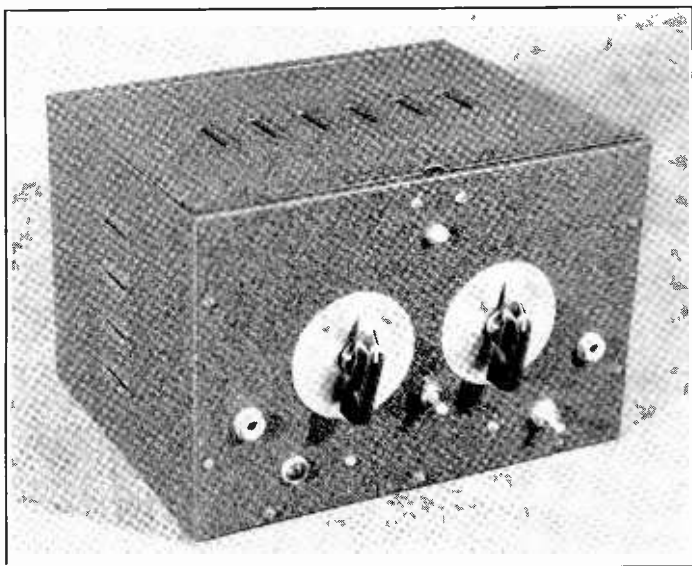

The complete portable phone or c.w. transmitter. The two large dials are on the oscillator and amplifier tank condensers. The antenna is connected to the insulator at the top center of the panel.

- C₁, C₂—100- μ fd., .020 spacing
- C₃—01- μ fd. 400-volt tubular
- C₄—001- μ fd. mica
- C₅, C₆—002- μ fd. mica
- C₇—10- μ fd. 25-volt electrolytic
- C₈, C₉—8- μ fd. 450-volt electrolytic
- C₁₀—8- μ fd. 450-volt electrolytic (use only if needed)
- NC—3-30 μ fd. mica trimmer with screw removed.
- R₁, R₂—100,000 ohms, 1 watt
- R₃—400 ohms, 2 watts
- R₄—50,000 ohms, 10 watts
- T₁—Single-button mike to grid trans.
- T₂—675 v. c.t., 70 ma.; 5 v., 3a.; 6. v. c.t., 2.5 a.
- CH₁, CH₂—30-h., 75 ma.
- S₁—S.p.s.t. toggle switch
- S₂—D.p.s.t. toggle switch (mike and negative B)
- S₃—S.p.d.t. toggle switch
- J₁—Closed circuit jack
- J₂—Open circuit jack
- P—Flashlight lamp
- B—Two flashlight cells
- L₁, L₂—Manufactured receiver coils, see text.

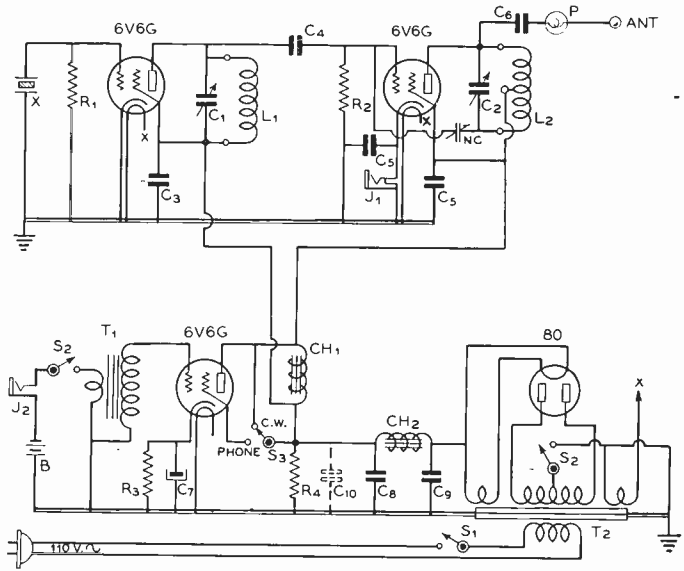

Wiring diagram of "Pidgee."

for the filter choke and filter condensers. Be sure to use the new midget dry electrolytics and then you can put them in most any place under the chassis. The rectifier is located along the rear in line with the modulation choke. Those two flashlight cells on top of the choke are the mike battery. Just in front of the transformer is the crystal socket (five prong), the oscillator plug-in coil and the oscillator tube. In the center towards the front is the r.f. amplifier together with its plug-in tank coil.

These plug-in coils are of the four-prong, 1½ inch diameter ready-made type for short-wave receivers. In case you do not buy a ten-meter coil, wind four turns triple spaced on a blank coil form.

The remaining tube is the modulator. All resistors and fixed condensers except the antenna series condenser, are mounted below deck and are soldered in place wherever they fit. The socket terminals make a very convenient place to connect a resistor or condenser. On top of the chassis in front of the choke is also found the "Phone-C.W." switch for turning off the modulator during code transmissions.

Two precautions should be observed in building a similar unit. First, in locating the mike transformer connect a pair of headphones to the secondary winding and hook the power transformer to the 110-volt a.c.

line. Then try placing the mike transformer in different positions, finally selecting the one that gives least hum in the phones. Second precaution: with the oscillator and rectifier tubes only in place, turn the set on and measure the voltage between the 6V6G plate and ground. If it is over 250 volts change the filter condenser next to the 80 tube over to the position shown by the dotted lines. This keeps the high voltage down within the working limits of the beam power tubes and prevents erratic behavior of the r.f. section.

And now let us take a look at the front of the panel. First of all we notice two silver dials, the one on the right being the oscillator tuning condenser and the left one, the r.f. amplifier condenser. These dials could just as well be something inexpensive but since they lend such a pleasing touch, a little splurge at this one point was felt justified. A pilot light is located in the lower left while the line switch is in the lower right hand corner. In the center is the "send-receive" switch. In the receive position the high voltage center tap is opened along with the mike battery circuit. This allows the tubes to remain heated during reception periods and in addition conserves the mike battery. The right hand jack is for accommodating a key when c.w. is used and the other jack for plugging in a microphone for phone operation. At the top of the panel may be seen

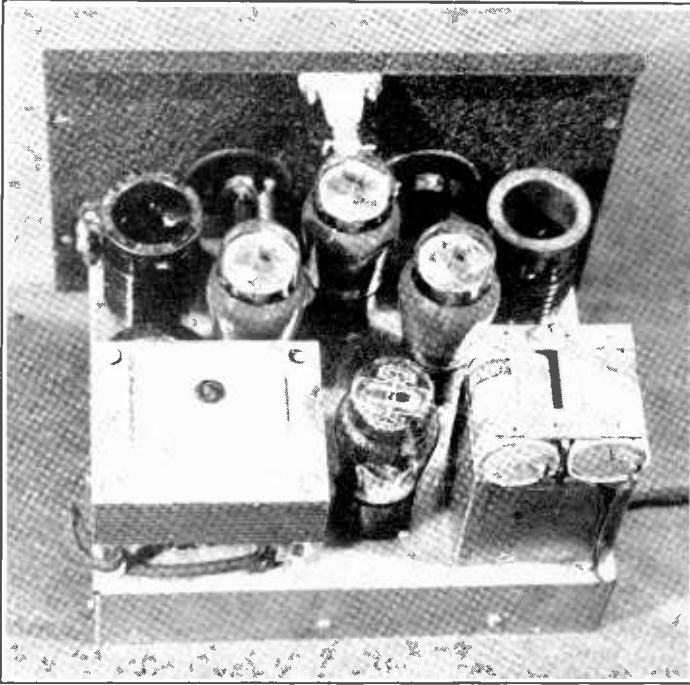

Above the chassis all available space is used. The power supply occupies the rear section, while the r.f. section is next to the panel.

the antenna flashlight lamp, mounted on a midget standoff insulator fastened to the back of the panel. A small binding post on this insulator serves as the antenna terminal.

Pidgee is very easy to handle; the tune-up procedure is very simple. Let's take a typical example of getting on the air, say on the 160-meter phone band. First plug in the line cord, turn on the line switch and let the tubes warm up. Plug in your pet crystal and the two 160-meter coils. Connect any length of antenna wire to the aerial post and a ground wire, if available to the chassis. At this point a resonance indicator will be needed. This consists of a flashlight lamp connected to two turns of hookup wire formed into a two-inch loop. Now turn on the "send-receive" switch, applying plate voltage to the tubes. Holding the resonance indicator over the oscillator coil, turn the oscillator dial to obtain the brightest light. It is usually best to set this dial a couple of points toward the low capacity side from the brightest position to obtain good stability. The oscillator is now tuned. Next, rotate the r.f. amplifier dial to the position giving the best brilliancy in the antenna lamp. Now plug in your mike, and Pidgee is all set to create an ethereal ripple. If the amplifier exhibits a tendency to self-oscillate, some adjustment of

the neutralizing condenser NC will be required. Usually, however, removing the adjusting screw from a 3-30 μfd . mica trimmer will give the correct capacity. If some adjustment of the capacity is required, simply bend the movable plate in or out until correct adjustment is obtained.

For operation on 80 meters, we can use a 160-meter crystal, a 160-meter oscillator coil and an 80-meter r.f. amplifier coil. On the other hand an 80-meter crystal and oscillator coil may be used together with the 80-meter amplifier coil. Thus one crystal will provide operation on two bands. Be sure to throw the "C.W.-Phone" switch to the c.w. side when keying the rig or the signal will not be very clean cut. If one wishes to check the plate current to the r.f. stage, a milliammeter may be plugged into the cathode jack. This also will give us a check on the modulation, for at no time should the reading of the meter vary while talking in the mike. If it does vary, the mike is being held too close to the mouth or the operator is talking too loudly.

As to actual results, the reports secured have been very satisfactory on all bands, using either phone or c.w. and antennas ranging from 40 feet to 250 feet in length. When

[Continued on Page 84]

Choosing the Swinging Choke

By C. A. M. MORGAN,* W9CGG

Swing's the thing, and lots of it. This applies not only to music for "jitterbugs" but to the input choke in a power supply filter. With the correct choke, lower voltage filter condensers may be used safely and more current may be drawn from the filter without shortening the life of the rectifiers.

Few hams are aware of the importance of choosing the correct swinging choke for use in a choke-input filter system. The general practice seems to be just to "throw" in any five-to-twenty henry job of the proper current carrying capacity, and to let it go at that. However, a little attention to this neglected unit is worthwhile, for it may be doing a lot of unsuspected things, such as chewing up the 866's by exceeding their rated peak current capacity or straining the filter condensers by allowing the peak voltage upon them to exceed the calculated value. Whether or not either of these undesirable effects occurs is to a large degree dependent upon having the proper minimum and maximum value of inductance in the swinging choke. These values may, or may *not*, be five henries and twenty henries respectively. A few simple calculations will clear up the situation for a particular case in no time at all, and the time spent in making them is more than repaid by the results.

First, it is absolutely necessary to know the load impedance limits of the filter output. These are expressed in ohms, and are found by dividing the output voltage by the total load current in amperes. This operation will have to be done twice, once for the minimum (bleeder) current and once for the maximum (full load) current. But let's take a concrete example: Suppose we have just finished a new push-pull 810 class "C" amplifier and want to construct a power supply to run it. Our amplifier requirements are 2000 volts at 500 ma. We buy a 2500-0-2500-volt power transformer, a 40,000-ohm, 100-watt bleeder (designed to pull 50 ma. or 10 per cent of the full load, which is common engineering practice), a 20-henry smoothing choke, and a pair of 866's.

There we stop buying, for the present, and start calculating. What is the minimum input

inductance that will enable us to draw the maximum current through our rectifier tubes without hurting them? The formula $L_{min} =$

Full Load Impedance
 $\frac{\text{Full Load Impedance}}{500}$ will give us the lowest

inductance which we can use with safety. The value obtained permits approximately 90 per cent of the peak current rating of the tube (90 per cent of 600 ma. for '66's) to be used in actual application to the load.

First we must obtain the full load impedance. We divide our 2000 volts by 500 ma. load current plus 50 ma. bleeder current or

$\frac{2000}{.55 \text{ amp.}} = 3640$ ohms. Then, $L_{min} > \frac{3640}{500} > 7.28$

henries. We see that we must obtain a choke which will swing *no lower* than about eight henries at full load in order to obtain good life from our rectifier tubes. Having the correct value of L_{min} will also allow us to draw $\frac{1}{3}$ more current from the power transformer for the same amount of heating, another advantage.

Now for the minimum value of no-load inductance. The ratio of no-load (bleeder) impedance to L_{min} determines what the voltage ratings of our filter condensers are going to have to be. If L is too low, the condensers will have to be purchased to withstand the *peak* a.c. voltage applied to the 866's. If it is sufficiently large, they will only have to take 0.9 of the *average* a.c. voltage (r.m.s.). In our hypothetical case, this means the difference between getting 2000-volt or 3500-volt units. To find this minimum recommended value of no-load inductance, we use

the formula, $L_{max} > \frac{\text{No Load Impedance}}{1000}$. The

* 1535 W. 75 St., Kansas City, Mo.

[Continued on Page 83]

Analyzing ANTENNA PERFORMANCE

By HAROLD E. TAYLOR, * W8RNC

In the last couple of years considerable attention has been given to the design of beam antennas. There are various ways by which one can compare antennas: by theoretical computations, measurements with field intensity meters or receivers, and by comparing reports from stations beyond the ground wave range. It is generally the latter method that most amateurs prefer in making comparisons.

Such reports in order to be of value must be taken over a period of time and representing a fairly large number of contacts or QSO's. This article describes a simple, workable method by which an amateur can analyze these reports and make an effective comparison between antennas. In general the plan consists of preparing a stroke record or tally sheet of all contacts made for some period of time and plotting a cumulative percentage curve for each antenna being studied.

Preparing Stroke Record or Tally Sheet

The stroke record or tally sheet is compiled on the form shown in figure 1 by entering one stroke mark in the proper signal strength column for each consecutive QSO. The above data can readily be obtained from the station log book over a specified time interval. If desired the entries may be made on figure 1 at the conclusion of each contact but the plan of taking the information from the station log book appears more feasible.

For example, if a report received was R9, enter a stroke mark under the R9 column. If the next report received from another city or state was R7 enter the stroke mark under R7. Place a similar stroke in the proper column for all other reports received. If the report received was QSA5, R7 to 9 it is suggested you use the maximum, average, or minimum report according to your personal choice. However, follow the same procedure in tabulating other reports of this nature.

* Route 2, Box 2539, Detroit, Michigan.

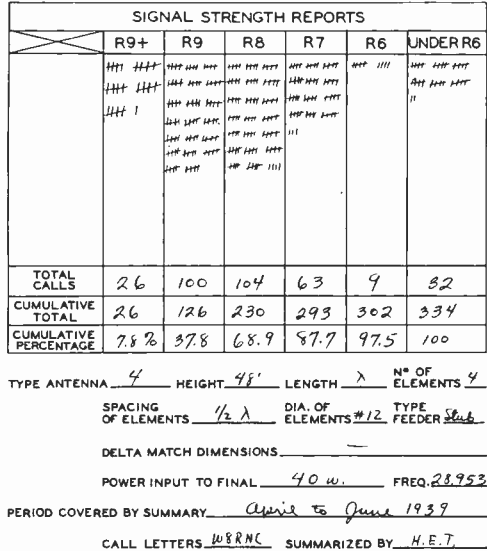

Figure 1. Stroke record sheet of signal strength reports.

After having placed all the stroke marks in the proper columns, add up the number of strokes in each column vertically. Having done this add up the column totals from left to right across the page horizontally for the "Cumulative Total."

The next step is to find the "Cumulative Percentage" for each column. Knowing the "Grand Total" of calls observed or reported, and the individual column cumulative totals, this is straightforward percentage as outlined in figure 1. For example, 26 divided by 334 gives 7.8 as the percentage for column 1 (R9+). For column 2, one divides 126 by 334, etc.

Plotting the Curve of Figure 2

The data compiled on figure 1 is in suitable form for the preparation of a cumulative

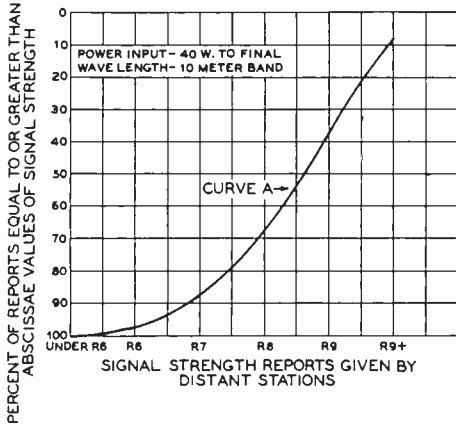

Figure 2. Cumulative percentage curve for antenna "A".

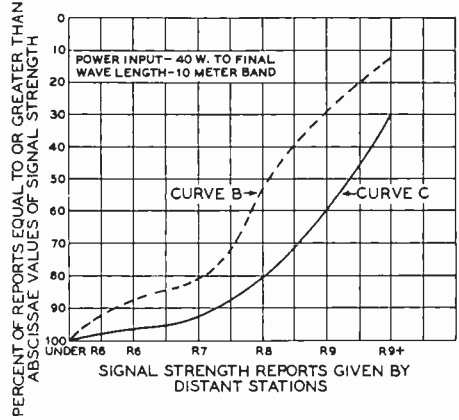

Figure 3. Cumulative percentage curves for antennas "B" and "C".

percentage curve an example of which is shown in figure 2. Signal strength reports given by distant stations are designated on the abscissae while the cumulative percentage is shown on the ordinate.

In applying this method to prepare the curve of figure 2, 334 telephone contacts were tabulated and reported. After having plotted this curve it was decided to see what would happen if only the first one hundred calls were tabulated and plotted. Both curves were drawn on the same sheet and scale; very little change took place in the results. Therefore, approximately 100 calls should be sufficient for most cases.

Analysis of the Curves of Figure 3

The curves of figure 3 are the results of a similar study on two other different types of antennas. This figure shows the performance of two antennas plotted to the same scale with the same number of calls made on each. It is evident from an analysis of the two curves in figure 3 that "C" is the better antenna.

Let us analyze antenna "B" versus antenna "C". It will be noted that 54% of the contacts made on "B" were R8 or greater and 28½% of the contacts made were R9 or greater while on antenna "C" 81% were R8 or greater and 60% were R9 or greater. Comparisons can be made of course for any point or points on the curves desired. The reason for not plotting the data below "Under R6" is because most amateurs are interested in fairly loud signals and it simplifies the computation. Also the reports under R6 would probably include most of the contacts

with stations lying considerably off the main lobe of radiation from the antenna.

Short-Wave Listeners

This method can be applied to one or more antennas used by short wave listeners on reception, provided of course they have an R meter or S meter on their receiver.

Conclusions

It must be realized that some reports are given by audible judgment instead of a visual indication. Also, the R meter calibrations of individual receivers vary considerably from one to another. However, experience with this method has shown that the error is slight and should not have any great effect on the overall analysis.

This plan of tabulating the performance of antenna systems is not infallible with regard to accuracy but it is felt that it is at least a start. The whole object is to arouse the interest of the individual amateur to keep some sort of a systematic record on his antenna performance.

• • •

Just about the ultimate in customer service is being delivered by a speaker manufacturer in Australia. When brush fires destroyed a great number of outland homes, notice was posted by this company that any loudspeaker salvaged would be completely rebuilt and returned to the owner, no matter in what condition it was received . . . entirely at the company's expense!

INEXPENSIVE D.C. RELAYS

● *from old auto-radio vibrators*

For many years amateurs were able to get excellent relays at negligible cost by adapting or converting the relays obtained from old Philco battery eliminators, but not many of these are left "floating around." Fortunately, there is now another source of inexpensive relays for the amateur: auto radio vibrators which have been replaced. These "defunct" vibrators can be picked up at little or no cost.

GEORGE M. GRENING,* W6HAU

The interest in amateur portable and mobile transmitters has created a strong demand for six-volt d.c. relays. The impecunious usually rewind generator cutouts or purchase horn relays. The latter draw an ampere or more and every cutout we have worked on seems to have the core riveted to the frame in such a manner that it was hard to rewind.

Amateurs have, however, been overlooking one of the cheapest sources of such relays in the form of auto radio vibrators. Since radio service shops rarely attempt to readjust vibrators, the supply of "duds" is unlimited. Inquiries at several local shops brought dozens to light.

Fortunately we have all the components of a relay incorporated in a vibrator, including the coil, movable arm and multiple contacts. The circular can makes both an excellent shield and a dust proof cover. The relay can be mounted in a tube socket, making replacement merely a matter of plugging in a new assembly. No coil rewinding is necessary and the current drain can be made quite small. The reeds, which are constructed to vibrate at 40 to 60 cycles per second, are fast enough to follow a bug with the weights off. The contact material is very hard, so hard in fact that much filing will dull a good file. The points on those examined have run between $\frac{1}{8}$ inch and $\frac{3}{16}$ inch.

The conversion will be found very easy. After examining the wiring diagrams of over

sixty models and converting a box full, we have yet to find one that cannot be used, assuming that the points are in good condition (not too badly burned). Even though it may no longer operate in an auto radio, in at least 75% of the cases the vibrator can still be used as a relay, the only exceptions being those in which the coil is open or points welded together due to a shorted filter condenser. In most cases the points are still in good condition but slightly out of adjustment.

Depending on the number of prongs on the vibrator, we can make either a single pole, single throw (normally open or normally closed) or a single pole, double throw. By using a synchronous type, the extra set of fixed points can be paralleled, giving twice the contact area.

Since there are well over a hundred different vibrator models, conversion data can only be given in a general way. Incidentally, many different auto radio manufacturers use the same make of vibrator mechanism but in their own can and under their own name.

Fortunately all types can be broken down into two principles of operation: those using a separate set of points to make the reed vibrate, identical to a door bell or buzzer (figure 1A) which we will call for convenience type A, and those in which operation is secured by having one of the points which interrupt the transformer primary current also short out the coil (type B, figure 1B). Each of these fundamental types is subdivided into those designed to operate with a tube rectifier and having two sets of in-

*Police Dept., Santa Barbara, Calif.

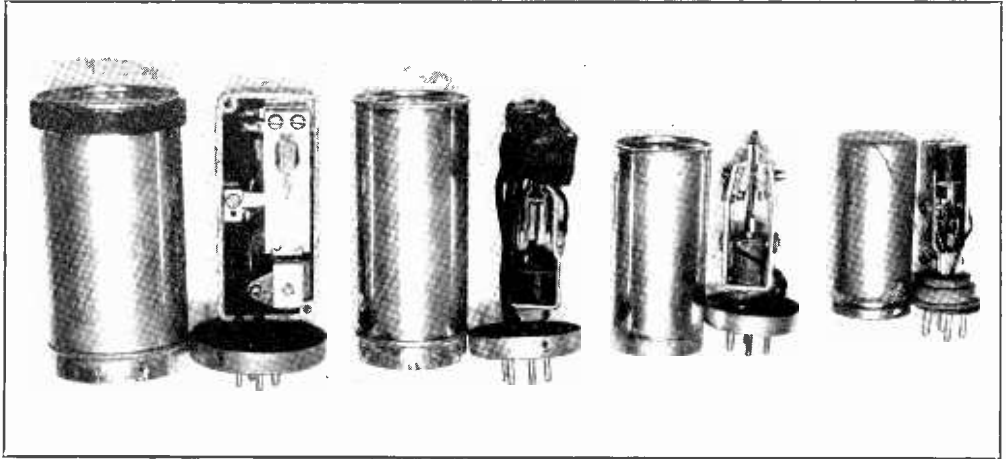

Various types of vibrators converted for use as relays. Left to right: Philco type A, Mallory type B, Delco type B, Oak type A. Type designations refer to figure 1.

erruptor points, and those to be used in a self rectifying circuit, called a synchronous vibrator, and having four sets of points. The former is usually incorporated in a can having four prongs and the latter in one having five or six prongs.

The vibrating reed and one side of the coil are almost invariably grounded to one prong and/or the frame of the assembly. Some cans are constructed with this ground prong riveted to the can proper, while others have all prongs insulated and grounding is accomplished by a soldered jumper inside. The latter is preferable, since it permits one extra contact lead to be brought out.

Figure 2 shows the completed conversion. Regardless of the type or prongs, the vibrator must be rewired to this diagram.

The first step, after testing the coil and inspecting and cleaning the points, is to in-

isolate the reed. This can be done by disconnecting the wire which grounded it and bringing a connection from it to one of the prongs. If the reed is clamped to the frame, remove it and insulate with thin fibre or mica. (We obtained our fibre by stopping a traffic officer and bumming the cover from his "ticket" book!)

If you are working on a type A vibrator, remove the fixed point entirely or bend it out of the way. The type B of course requires no such change.

Leave alone both the coil lead which goes to the insulated prong and the fixed contact leads.

If the type A is non-synchronous, there are probably four prongs. If one is riveted to the can and this ground cannot be removed, use this prong for the connection to the ground side of the coil. The vibrator can then only be wired as a S.P.S.T. relay unless it has five prongs or it is permissible to bring a flexible lead out the side of the can. If a four prong vibrator and all prongs are insulated, connect the metal assembly shell, through a hole in the can, to the can itself. The latter makes a S.P.D.T. relay with the

[Continued on Page 84]

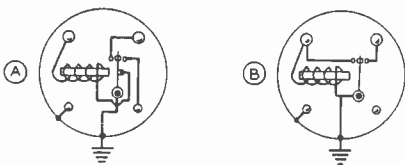

Figure 1.

Showing internal connections of two fundamental types before conversion. Type A use separate set of points to make the reed vibrate; type B do not. Connections to prongs vary with different models, the order illustrated being a common one.

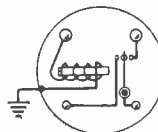

Figure 2. Illustrating connections of vibrator converted for relay service. If vibrator is of the synchronous type, parallel the fixed points.

Meet Your DX IN PERSON

By JO and BILL CONKLIN *

PART II. CONCLUDED FROM NOVEMBER, 1939, ISSUE.

Tulip Time in Holland

Early on a sunny day—not promised by guide books—we arrived in the Netherlands at IJmuiden. All that could be seen were some narrow strips of land, like stone-lined levies, with water channels between. The *Kungsholm* was tied up to some piling, making it necessary to take a small boat around to where cars were waiting.

The Kingdom is 196 by 109 miles, bounded by Germany on the east, Belgium on the south, and the North Sea on the west, north, underneath and above. Something over a quarter of the area is actually below sea level, making it necessary to have strong dikes along the Rhine and Scheldt rivers which carry a tremendous boat traffic. Branching off are canals at a lower level and then still smaller canals. It is necessary to pump rainwater and seepage from the lower canals to higher

*W9SLG and W9BNX (ex W9FM), Wheaton, Illinois.

ones, either by windmill or more reliable electric pumps, in order to prevent floods. Dikes are often used for roadbeds, while canals a few feet wide may be used instead of fences to keep cows in the proper fields, or to provide a place to store a tulip-grower's speedboat. There are said to be 1500 miles of dikes and 4500 miles of canals, which are of great importance to internal communication whether for bringing an ocean liner from the East Indies overland to Amsterdam, or to deliver coal to the attic of a city house via block and tackle. There will be more canals soon, for the large Zuider Zee has been dammed and is being pumped out to provide additional area for dairy farming.

The tree-lined road to Vollandam took us over many bridges across canals. The city itself was at first disappointing until we found that there is more to it than the tourist-conscious main street built on the dike. The spotless little houses appear to have only



SM6UA, the station of J. F. Karlson at Goteborg, Sweden.

PA ϕ FB, near The Hague, at the operating position of his station. The ten-meter rig, using a WE304A in the final, is well known among 28-Mc. men in this country.

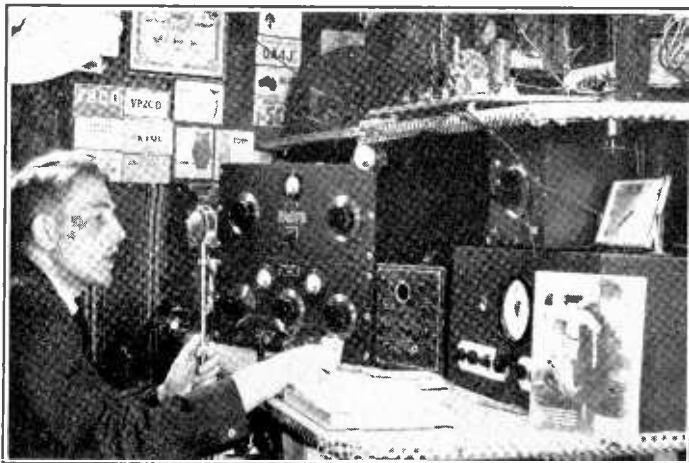

one room. The glossy windows are cleaned with the help of a very little sulphuric acid in the wash water. Children going to school wear wooden shoes, picked out with considerable accuracy from among those outside the door; we did see one girl get into only one, then hop about until she singled out the other.

PA ϕ BB

It was in Vollandam that PA ϕ BB located us by telephone, having missed us when he and PA ϕ LR called at Ijmuiden. We met him outside of the museum in Amsterdam where we had seen Rembrandt's *Night Watch* and had accomplished the unusual by taking colored movies of painting. PA ϕ BB took us across Amsterdam showing us the canals, the Queen's palace, and other sights. Bicycles are the standard of transportation, whole families pedaling along with the smallest children riding in baskets. Cyclists wear license tags pinned to their clothing.

PA ϕ BB has a 100-watt transmitter in a suburb of Amsterdam. He said that there is a 24% duty on radio equipment. No foreign tubes are sold; Phillips tubes made in Holland are almost exclusively used. Being a journalist, he was in a position to give us the latest international news. He pointed out that there was at that time no evident censorship outside of the Axis powers except for the restrictions upon news in Britain during the Munich crisis. On the street we passed a friend of his who had escaped over the border from Germany. We were told that perhaps a third of the refugees were not Jewish but had left their country for reasons other than the pogroms.

PA ϕ FB who is located two miles from The Hague and three from the North Sea, wanted

to meet the ship but did not obtain the arrival time early enough. He is very well known on this side, particularly on ten meters. The tube lineup of the main transmitter is 56-53-TZ40, while the ten meter job starts with a 6L6 40-meter tritet, a 6L6 doubler and WE304A final. This 50-watt job has been sufficient to snag a 28-megacycle phone WAC. The receiver is an RCA type ACR 175 with 6K7 preselector. On all bands from 10 to 80, a forty-meter zepp suffices.

Behind the Central railway station in Amsterdam we located the steam packet Aalkmar that was to take us through the canal to the North Sea, among many large ships, and small brown-sailed boats. It was odd seeing only a roof or the upper story of a nearby house, the rest being below the water level. After passing through the inevitable lock, we boarded our ship again to sail past the German coast and the sand dunes of Denmark on our way to Gothenburg, Sweden.

Sweden

After a night in Gothenburg, we awakened to find a "Welcome to Sweden" sign outside our porthole, and the crew of the home coming *Kungsholm* in high spirits. Sweden is a thousand miles long, three hundred miles wide. Most of it is bordered by the Baltic, with Finland alongside at the Northeast (not Russia as this is written), and Norway at the northwest, but it has an important North Sea coast on which Gothenburg, its second largest city and busiest port, is situated. A good part of the country is rolling, with planted fields between the hills, crossed by many stone fences built by piling up the rocks turned up during plowing. Some said that it looked like New Hampshire but we



G6DH, G6CL, G2ZV, and 2DDD visiting R.S.G.B. Headquarters in London.

thought that it was quite like Wisconsin and Minnesota where the Swedes feel "at home." Farther north, there are many valleys, rivers, and waterfalls. Twilight lasts until dawn in June, and in the north the sun can be seen at midnight.

Gothenburg, home of SM6UA and SM6VX, is a little more than 300 years old. Many Dutch buildings and even canals may be seen there. Predominant were large buildings of light stone, with rows of identical windows, but there were many more irregular older ones topped by green-roofed towers. The city, about half way between Oslo, Norway, and the southern end of Sweden, is at the North Sea end of the Gota canal on which it is possible to go to Stockholm on the Baltic side on small freight and passenger packets.

Stockholm is better known, being the seat of the government and the royal residence. Fewer know that with its waters and islands, it has much of the charm, atmosphere, and

inconvenience of Venice. It is a city of half a million out of over six million people in the whole country. Many of the newer buildings are in a modern style of architecture.

Denmark

A clean electric train took us down the Swedish coast to within a two-mile ferry ride from Denmark, or at least the Island of Zealand on which Copenhagen is located.

The ferry landed us at Elsinore, site of Kronborg Castle which was made famous by Shakespeare as the scene of *Hamlet*. Towns- men can even point out the brook where Ophelia was drowned! The castle commands the narrow sound between Denmark and Sweden that provides the only outlet for heavy shipping from the Baltic to the North Sea except for the channel on the other side of the island and the Kiel canal just across the German border.



G2HC, G2ZQ, G2CB, G2NK, G8DN, W9SLC, and G6WY at G2HC's house.



Snapshot of the screen of G6OT's television receiver, showing announcer. One second exposure, F.3.5, Super XX film, camera held in hand with no support.

The drive to Copenhagen took us by homes which, like in Sweden, were much more varied in their architecture than in other European countries. Everywhere there was a flagpole with a Danish flag or long streamer flying. There were woods with wildflowers visible from the roads, but mostly the low-lying country is farmed, producing with Holland the bacon, butter and eggs used on the English breakfast table. There were paved bicycle paths between the street and the sidewalk, the cycles presenting a greater traffic problem than automobiles. The city has many

boulevards of normal width making driving as pleasant as in Paris.

After sightseeing and dinner, we went to the Tivoli Gardens, a Coney Island right in the center of the city, best known in Europe with the possible exception of Luna Park in Paris. Here there was an open-air play in pantomime, and a number of orchestras playing classical music to full houses while most other amusements were poorly attended. Another indication of the class of people was given to us by a young blond soldier who, every time his little electric auto bumped another, tipped his hat with a smile.

The OZ Hams

OZ7GL tried to arrange a visit with us but a change in the itinerary and the fact that Cook's did not know where we could be located, made it impossible. At the hotel we telephoned OZ7SS who tried to round up OZ4H and OZ7GL but at the late hour of nine p.m. did not produce an invitation to visit a station. Inquiries about the European situation were met with a complete lack of interest in anything but peace and neutrality. There was not even any worry that Germany might want to retake the two southern provinces that had been returned to Denmark.

While in France it was the pillows that were sewed into the sheets, here it was the blankets which, consequently, could not be tucked in at the sides. Breakfast was not of the continental variety at all, but included grapefruit cut perfectly without chopping up



2DDD, G2ZV, VU2AU, G2YL, Mrs. Corry, W9SLG, Mr. Corry, in front of G2YL's wall paper and rig.



VU2AU, W9BNX, W9SLG at G2YL's.

the webbing, and sweet rolls that were a dream.

Germany

At this point we "jumped ship," to fly to Berlin and on to London. The plane from Copenhagen was easily identified as Swedish by the prefix to the registration number. It was a German Junker similar to our DC2, with the radio operator acting as steward. The flight took us over the southern tip of Sweden, then on across the Baltic to the low-lying fields of northern Germany, arriving at Berlin within an hour and a half of the take-off.

Cameras could not be used from planes traveling in Germany, but there were no restrictions even upon taking pictures at the airport. Tempelhof is being enlarged by construction of new hangars, with heavy steelwork, at the very edge of the available area. It was the only steel seen in any of the many buildings going up or being rebuilt. Concrete was used on all others.

The information man at the airport greeted us as neighbors when he heard that we were from Chicago, which he had left for a job in Germany, retaining his U. S. citizenship. He had a butter quota card but preferred the plentiful supplies available from farmer friends. He had seen window smashing, which he did not like, but was convinced that it was the Jew's own fault.

DE-0853

B. Vermehren whose receiving license is DE-0853 met us. He was born in South Africa, and spent several years in Buenos Aires and London working in his father's exporting business. This gave him a command of languages which he uses to help Dr. Slavick, D4BUF, who is foreign secretary of the D.A.S.D. when he is not working on television.

The German club, D.A.S.D., requires its members (who pay a mark a month, equal to forty cents at par of exchange) to attend weekly meetings for instruction, and handles the issuance of licenses. There are 6000 members but only 600 licensed transmitting amateurs of which about 450 have been active. It costs two marks a month for a broadcast or amateur receiving license. The amateur receiving ticket requires a code test of five words a minute, a technical examination, and a monthly

report of at least sixty stations logged. After two years, it is possible to be examined for a transmitting license but after that it may be a year or more before the ticket arrives due to the regulations, the post office and military approval necessary. Transmitting tubes are Telefunken, receiving tubes are German Phillips; it has been almost impossible to buy ours because of the absence of adequate foreign exchange for even the raw materials Germany needs to buy from other nations, the lack of which was everywhere blamed upon "encirclement" policies of Great Britain!

Everywhere there was ballyhoo about the new era, everywhere conviction that only Germany is prosperous. Vermehren was astounded at our denying his comment that there are beggars all over the streets in the U.S. The Europeans understand that we have fifteen million people unemployed, without considering that many may be driving their own cars to work on a W.P.A. project paying better wages than for equivalent work in Europe. There were many evidences of unusual policies in regard to news, with foreign papers and magazines censored by permitting only some issues to enter the country, others being completely suppressed.

What, No War?

Several people expressed a conviction that

there would be no war. Even then—in May—the army was believed ready to step in and take the Polish corridor, but it was pointed out that France and Great Britain should not be disturbed by such a little thing way off in the east. We raised a question about what would follow the taking of the corridor, the answer to which was, "if we had a desire for more territory we should have taken all of Czechoslovakia instead of merely making a protectorate of it." It was said that the rules under which people in Germany live are not more numerous than before, they are just different.

The old linden trees on "Unter den Linden" were replaced with young trees, now fifteen feet tall, to celebrate the new era. Quite a few uniforms were evident on the men, some of whom were aviators but most were police, and S. S. or S. A. troopers who are business men wearing their uniforms one or two days a week. On the Wilhelmstrasse, the street of embassies and government, there were many of these troopers standing grim and motionless guarding doorways. In fact, we saw only three people smile or laugh during a day of sightseeing in Berlin, and only one patch of flowers which was at the airport. We could not explain why we felt relief from suppression at six p.m. when the plane took off for Holland and England. It was a most interesting day, in which we saw from the air or ground five European countries starting at Sweden and ending at England.

Merry England

Our plane crossed the English coast line di-

rectly above G6DH, and landed at Croydon which is a southern suburb of London. E. Humphrey Swain, G2HG, and George Dakin, G8DN, were at the airport to meet us even at the late hour of our arrival. The next day was beautiful, bringing the Londoners to the flower adorned parks where they visibly enjoyed the sunshine. The parks were dug up here and there where air raid shelters were being finished. We could not walk a block with guide book in hand without someone stopping to inquire courteously if he could direct us anywhere, but except for the very numerous cars driving on the left side of the streets and the almost understandable cockney of the bus conductors, we had no trouble.

In London one soon finds that history is alive rather than dead. A general survey from prehistoric times is obtained quickly at the London museum, while a visit to Westminster Abbey, the coronation church of England since 1066, will round out the last ten centuries. Not far away are statues of "those rebels," Washington and Lincoln!

G2DH and G8DN took us about London and to London Tower, which only one of them had visited when quite young. A good share of London was already there. We were amused at the increasing size of the armor of Henry VIII as his years—and wives—passed by; and by the good nature of the "beefeaters" who let us into the "bloody tower" on children's tickets that had been purchased accidentally at a machine. There were only two guards—unarmed—in the room with the crown jewels. We returned to the hotel just fifteen minutes after the fighting

G6CL and the rig on which we raised W3FUN.

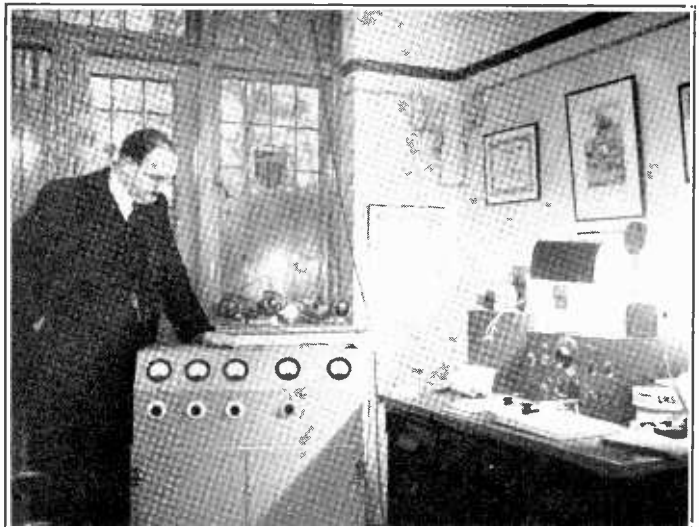



Hilton O'Heffernan, G5BY, and his 56-Mc. receiver with the rig in the background.

Irish Republican Army had set off a bomb in the subway station in the basement.

G5BY, Croydon

An evening trip to see Hilton O'Heffernan, G5BY, was quite enjoyable. Hilton just has room in his yard for a tennis court and his several antennas. His new receiver has a front end for 56 Mc. and another for the lower frequencies, using the same i.f. and audio. The five meter band was active but G6FO, across England, did not break through as he usually does.

Hilton has been recovering from typhoid fever for the past year or so, having caught the disease from the Croydon water supply. Some people in England actually do drink water, but when W9SLG asked for "watt-er" in good Indiana style, G8DN had to translate it as "whoa-ter" before one waitress could get over her astonishment at the unusual request. DN's wife thought it odd that we had never eaten kidney pie, but she had never tasted corn. Eating is not the problem in England that it is in France or Morocco—especially breakfast which is everything we eat plus a meat or fish course, and followed by a fruit salad after the coffee. It is no wonder that one can get along on only tea and a dinner after such a breakfast which, of course, goes with the hotel room. The English see no sense in switching one's fork to the right hand before taking a bite. They are inclined to eat left handed except for cutting with a knife or, in the case of that breakfast fruit salad, with a tablespoon.

London Television

G6DH, G2ZV, G2DN and 2DDD called upon us at the hotel. After luncheon, we all went over to the headquarters of the Radio Society of Great Britain where J. Clarricoats, the Secretary, extended an invitation to come out to his shack. He had a very nice little grey metal rig that had been described in the *T & R Bulletin*. We tested it by raising W3FUN. After being satisfied that the G's can get along with only a few watts, we called on H.A.M. Clark, G6OT, who is a television engineer with the British Broadcasting Company. Everyone was watching the television, which had an 8 by 10 inch screen and was very satisfactory. No horizontal lines were visible except within four feet of the screen, using 405 lines and 25 frames a second. The picture quality in actual use appeared to be as good as the still picture demonstration of General Electric at the New York fair.

The B.B.C. sound broadcasts do not always provide an interesting variety of programs, but have created a new indoor sport. Londoners speak English with a variety of accents, but different from them all is "B.B.C. English." A group listening to a broadcast may suddenly burst out in laughter because of some word spoken in a style that the B.B.C. has decided upon as being proper. To us, it just sounded like good English.

G6OT had a five meter rig in the attic, including a rather sensitive acorn superhet. We did not happen to hear any signals be-

[Continued on Page 88]

AURAL COMPENSATION

By E. CARL HALL,*

Variable accentuation and attenuation of both lows and highs is desirable not only in an amateur receiver (especially if it is also used for broadcast entertainment) but also in the speech amplifier of a phone transmitter. A simple circuit for such provision is described in this article.

He was a wise philosopher who first gave the name *aural compensation* to the lowly tone control system, because after all it is the function of the tone control in an audio amplifier to change the various frequency components which reach the listener in the form of sound waves, so as to compensate for the peculiarities of his individual ear.

It is well known that the human ear is more sensitive throughout the middle range of audible frequencies between, say, 250 and 2500 cycles per second, than it is at frequencies above or below these limits. Because of this, the beauty of a musical selection is enhanced if the highs and the lows judiciously are increased in level. In listening to speech, however, with an ear for intelligibility rather than for melodious timbre, it is found that all of the important word sounds are contained within this middle range and that the inclusion of other frequencies, especially those below 250 cycles, results in a distinct masking effect which reduces the clarity of the message.¹

The ideal tone control, then, should accomplish a dual purpose. First, for broadcast reception it should provide a variable degree of emphasis on lows and highs without affecting to any extent the middle tones. Second, for point to point phone reception it should permit of a variable degree of attenuation of the highs and lows. It would be of additional value for c.w. reception if this attenuation could be carried to the extent of peaking the audio amplifier at 800 or 1000 cycles, thus providing A.F. selectivity between two carriers which are so close together that they

[Continued on Page 80]

¹ Paddon, "Optimum Speech Characteristics", RADIO, July, 1939.

* 4006 So. Figueroa, Los Angeles, Calif.

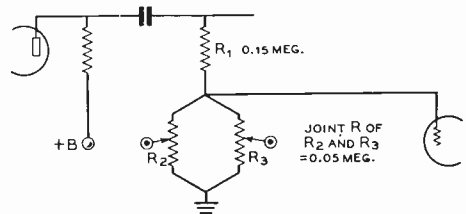

Figure 1. A novel tone control in which the potentiometer R_2 controls the lows while potentiometer R_3 controls the highs.

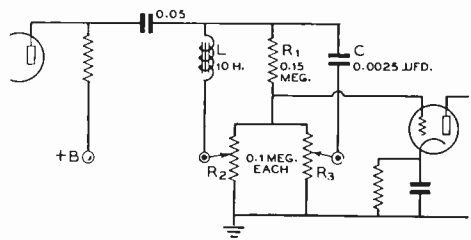

Figure 2. Grid signal voltage is one-fourth of the impressed voltage because the resistance from grid to ground is one-fourth of the resistance of the combination.

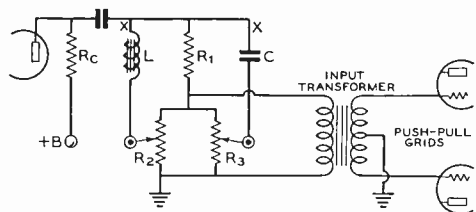

Figure 3. The circuit of figure 1 installed between a 76 and a pair of 42's. Switches on the potentiometers were installed at x-x so that the tone control could be made inoperative.

Control System

for C. W. and Phone

Mr. Forrest S. Belcher, W9CDQ, has submitted a circuit in use at W9UOG which allows both voice-operated carrier control and vacuum-tube keying to be obtained with a single set of keyer tubes. The actual circuit in use at W9UOG is shown in the accompanying diagram.

The basis of the control system is the keying circuit shown on page 208 of the 1940 RADIO HANDBOOK. This arrangement uses a number of 45 or 2A3 tubes in parallel to handle the plate current of the keyed stage. Then there is another 45 tube connected as a half-wave rectifier from the small power transformer T_2 to supply a high negative bias to the grids of the control tubes through the RC filter, C_4 - R_5 , and the series resistor, R_3 . Thus the control tubes are normally biased to cut-off when the key is up. When the key is pressed the small bias supply is shorted through R_3 and the grid condenser C_3 is discharged to ground through the resistor R_4 . The time constant of this latter RC network determines the rate of build-up of the keying pulse. When this combination has discharged

to ground (a matter of a few thousandths of a second) the grids of the keyer tubes will be at ground potential and the carrier will be at full strength.

Then when the key is lifted condenser C_3 is again charged through resistors R_3 and R_4 to raise the bias on the keyer tubes to the cutoff value. In this case it is the values of R_3 and R_4 in series with C_3 which determines the rate of decay of the carrier pulse.

Voice-Operated Carrier Control

The additional equipment required to adapt the circuit to voice-operated carrier control for phone is connected into the circuit by switch S_1 and is shown above this switch in the circuit diagram. A 1-V rectifier tube is connected to the secondary of a small audio transformer, the primary of which is connected to the two plates of the drivers or to another source of considerable audio speech voltage. The voltage divider R_1 and R_2 in series with the return of the 1-V rectifier determines the threshold level at which the car-

[Continued on Page 83]

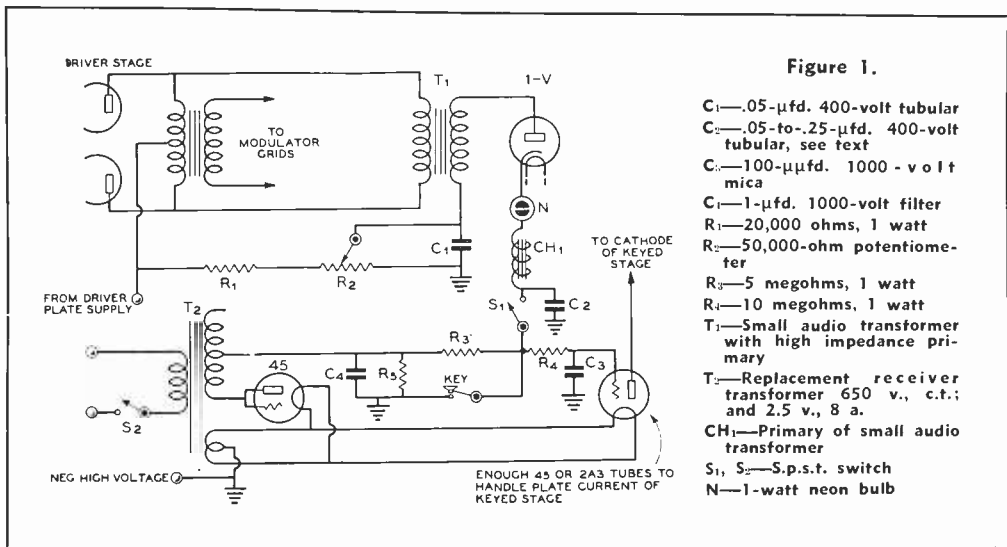

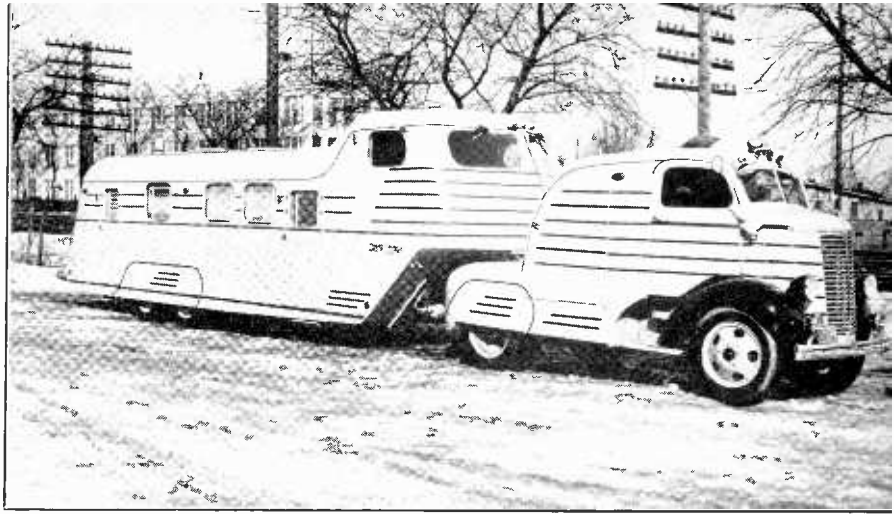

Probably the most elaborate amateur mobile installation in the world is the outfit shown above, operated on 10 meters phone by W2KJY. A Hallcrafters HT-1 and Hammarlund HQ-120 make up the station equipment.

DEPARTMENTS

- **DX**
- **The Amateur Newcomer**
- **U. H. F.**
- **Postscripts and Announcements**
- **New Books and Catalogs**
- **What's New in Radio**
- **The Open Forum**
- **Yarn of the Month**

RADIO

"WAZ" HONOR ROLL

CW and PHONE Z C				PHONE							
ON4AU	40	158	W2BXA	38	111	W2IZO	36	92	W3LE	38	123
G2ZQ	40	148	W6GRX	38	111	W5ENE	36	91	F8UE	38	103
W8CRA	39	156	W3FQP	38	111	W4ADA	36	90	W6OCH	36	105
W2BHW	39	156	LY1J	38	110	W9LBB	36	90	W6ITH	36	97
W8BT1	39	154	W1AB	38	110	W8JAH	36	89	W3FJU	36	87
G6VY	39	151	W6HZT	38	110	W1APU	36	89	VE1CR	36	81
W6CXW	39	150	W1AQT	38	103	W9GKS	36	89	W9NLP	35	95
W6GRL	39	150	W9ELX	38	103	OK2HX	36	86	W9TIZ	35	93
W9TJ	39	149	W8KWI	38	108	VK2NS	36	84	KA1ME	35	79
W2HHF	39	149	W3BEN	38	108	W6TI	36	80	F8VC	35	78
W2GTZ	39	149	ON4HS	38	108	W9GNU	36	80	W4CYU	34	93
W6CUH	39	143	W8JIN	38	107	W6GCX	36	76	W6EJC	34	84
W6KIP	39	143	W8BOX	38	106	W7DSZ	36	73	W7BVO	34	80
W8OSL	39	143	W9ADN	38	106	W2GXH	36	71	W4DAA	34	71
W6ADP	39	140	W9KG	38	106	W8OXO	35	113	W1ADM	33	83
W6BAX	39	140	W9CWW	38	106	W8LFE	35	109	W6NNR	33	88
W4CBY	39	138	W8OE	38	106	K4FCV	35	105	F8XT	33	70
W6DOB	39	138	W8GBF	38	105	W6GHU	35	103	W3FAM	33	68
VK2EO	39	133	ON4UU	38	104	W4QN	35	103	W6MLG	32	92
W9TB	39	134	W9PK	38	104	W8OUK	35	99	W2IKV	32	90
W2ZA	39	134	G2IO	38	103	W8CJJ	35	98	ON4HS	32	89
G5BD	39	133	J2KG	38	95	W6HJT	35	98	W8LFE	32	89
W2GVZ	39	132	G6XL	38	95	W2WC	35	98	W9QJ	32	86
W3EVT	39	131	ON4FQ	38	92	OK1AW	35	96	W1HKK	32	85
W6QD	39	130	W9VDQ	38	79	W8AAJ	35	96	W8QXT	32	85
W5KC	39	129	SU1WM	37	138	W3RT	35	95	G5BY	32	85
W2GWE	39	129	W2BJ	37	134	W9EF	35	94	W9BEU	32	85
W6KRI	39	129	W6GAL	37	131	G6QX	35	94	W4DSY	32	84
VE4RO	39	126	W8KKG	37	127	W6AQJ	35	92	VK4JP	32	84
W4CYU	39	126	W7AMX	37	125	VE5ZM	35	92	W6OI	32	72
W7BB	39	123	J2JJ	37	123	W8LDR	35	91	W6IDR	32	79
W6HX	39	123	W2IOP	37	122	LU3DH	35	89	W3EMM	31	87
G5BJ	39	120	W1RY	37	117	W9GNU	35	88	W1AKY	31	87
W2IYO	39	119	W3GHD	37	116	K6NYD	35	86	W8LAC	31	85
W2CYS	39	117	G6NF	37	115	W6KQK	35	85	G6BW	31	83
G2LB	39	115	W8ZY	37	114	W9ERU	35	83	G3DU	31	78
W4IO	39	115	W9RCQ	37	114	W6ONQ	35	83	W6FTU	31	77
W7DL	39	115	ON4FT	37	112	ON4NC	35	82	G8MX	31	71
W6FZL	39	112	W9RBI	37	112	G16TK	35	80	W8RL	31	67
ON4FE	39	110	W6ADT	37	111	W4ELQ	35	80	W6AM	31	66
W6FZY	39	109	W3TR	37	111	W9VDX	35	80	W9UYB	31	66
W9NRB	39	98	G2MI	37	110	W6MUS	35	76	F8KI	31	58
W6SN	39	95	VE2EE	37	108	W6HEW	34	103	W9ZTO	31	53
W6GPB	39	94	W4DMB	37	108	W9PGS	34	103	W2GW	30	86
XE1BT	39	90	W4MR	37	104	K7FST	34	102	W1JCX	30	81
K6AKP	39	67	W3KT	37	103	W8BSF	34	100	W2AOG	30	77
W1BUX	38	152	W9PTC	37	103	W2BZB	34	99	W9BCV	30	68
W1CH	38	150	W6ITH	37	103	W1APA	34	96	W6MZD	30	52
W2GT	38	143	W3FJU	37	103	VK2AS	34	94	W2IXY	29	93
W2GW	38	143	W9GBJ	37	103	W8HGA	34	93	W4BMR	29	80
W5VV	38	143	G6GH	37	102	W3EYY	34	91	W6NRW	29	60
W3HZH	38	139	W3AYS	37	102	W8NV	34	91	KA1CS	29	59
W3EMM	38	139	VK2DA	37	101	W2FLG	34	89	C02WM	28	70
W8BKP	38	138	W6FKZ	37	101	W6TE	34	86	W9RBI	28	70
W5BB	38	134	W6JBO	37	101	G6WB	34	83	W8AAJ	28	66
W9GDH	38	134	W8KPB	37	100	W6CVW	34	88	K6NYD	28	66
W3HXP	38	133	W4DMB	37	100	VK2OQ	34	87	W6PDB	28	65
W8OQF	38	133	W9AJA	37	99	G5VU	34	85	W7EKA	28	63
W8LEC	38	131	W4EQK	37	99	W9BCV	34	83	VE2EE	28	62
W4FVR	38	130	ON4VU	37	99	ZS1CN	34	82	W4DRZ	28	62
W9FS	38	130	W3EXB	37	98	VK2TF	34	81	W1BLO	28	62
W9TB	38	130	ZL2CI	37	97	W6MJR	34	81	W6NLS	28	61
W3EAV	38	130	W6MHH	37	95	W6PNO	34	81	VK2AGU	28	61
W2GRG	38	127	G2UX	37	91	ON4SS	34	80	W6GCT	28	56
W8JMP	38	127	W2BSR	37	90	W6HIP	34	76	W3EWN	27	93
ON4EY	38	126	W6MCG	37	84	VK2TI	34	75	W2HCE	27	76
W3EVB	38	124	W9UBB	37	77	W7AVL	34	75	W2GRG	27	73
W3EPV	38	121	W8AQT	36	120	W8JK	34	75	W2IUV	27	68
W8AU	38	120	W6MVK	36	117	ZL2VM	34	72	G6DT	27	59
W8LYQ	38	120	W6MEK	36	112	W6LHN	34	71	W5CXH	27	52
W8DFH	38	119	W8JSU	36	112	VK2AGJ	34	70	G5ZJ	26	77
W9PST	38	119	W3GGE	36	106	VK2EG	34	70	W5ASG	26	62
W8QXT	38	119	W6BAM	36	106	VE5MZ	34	69	W8NV	26	62
W8DWV	38	118	W8DOD	36	106	W8QIZ	34	68	W4EQK	26	61
W1GDY	38	118	W9AFN	36	105	VK2VN	34	63	W8QDU	26	61
W2BMX	38	118	W8QDU	36	105	W9QOE	34	56	W5DNV	26	60
W6AM	38	117	SP1AR	36	103	F8XT	33	112	W5VV	26	59
W1ADM	38	117	W5ASG	36	104	W8ACY	33	106	VK2OQ	26	56
LU7AZ	38	116	W5PJ	36	103	W6GK	33	101	W4TS	26	54
W3DDM	38	116	W6NLZ	36	103	W6KEV	33	96	W6MPS	26	51
W9UQT	38	116	W8PQQ	36	103	W8BWC	33	93	VE4SS	26	50
W3GAU	38	115	W6NNR	36	100	W8CED	33	94	W6FKK	26	47
W8MTY	38	114	W6KWA	36	99	W6MEK	33	91	K6LKN	26	46
W9KA	38	114	W8LZK	36	99	W9VKF	33	91	G6CL	26	46
W6VB	38	113	G6BJ	36	99	W6KUT	33	90	W3FQP	25	65
G6CL	38	112	VE1DR	36	98	W8LFE	33	89	W8NYD	25	60
W8HWE	38	112	W8AAAT	36	96	W6CEM	33	88	VK2TR	25	56
W1BGC	38	112	W6DLY	36	96	W9TJI	33	88	W8DBC	25	55
G2QT	38	112	ZL1HY	36	95	W3DRD	33	87	W8JK	25	47
W8EUY	38	112	G6YR	36	94	W6ANN	33	86			
			W7AYO	36	94	W8BWC	33	85			
			VE5AAD	36	92	W8MFB	33	85			

DX

AND OVERSEAS NEWS

by Herb. Becker, W6QD

Send all contributions to Radio, attention DX Editor, 1300 Kenwood Road, Santa Barbara, Calif.

Here goes for a last minute splash on RADIO's World-Wide DX Contest. A great many of you will receive this issue before the first week-end of the Contest and just to refresh your memory I'll run over some of the high points. For complete details look in October RADIO, page 48. Since this World-Wide Contest is our first, we are anxious for as wide a representation as is possible. We know that with the unsettled conditions overseas, dx will be reduced a great deal. However, we as dx men *cannot* let it affect us to the extent that we adopt the attitude of . . . "What's the use."

During the past month many fellows had a faint idea that RADIO would cancel the Contest, but at the same time in their letters to this department, they expressed the hope that we would continue plans, and hold the Contest. It surely shows the mighty fine spirit of the gang and we are hoping for conditions to be favorable. Most of the fellows reflect swell spirit in saying, "Sure I'll be in there pitchin' because dx is dx, whether it is one station or a million."

I wish you could read a few of the letters that were received from some of the dx'ers overseas, who are at present closed down. Here is a quotation from one—"Gee, Herb, with my hobby gone, my spare time is a blank. All I can do is to listen occasionally. We are all looking for you

USA boys to keep the ham bands alive and open . . . etc." . . . This same general feeling was expressed by several others and it truly shows that the dx man's fraternity throughout the world has no equal.

The "World-Wide Contest," which should be a break for the working man and those in school, will be over two week-ends, with 48 hours each. The starting time each week-end will be 0200 G.m.t. November 25 and December 2. Finishing times are 0200 G.m.t. on November 27 and December 4. As you can see, in England this is 2 a.m. Saturday to 2 a.m. Monday. For clarification this would mean the contest would begin at 9 p.m. Friday November 24 on our East Coast; 6 p.m. Friday on the West Coast; 3:30 p.m. Friday in the Hawaiian Islands.

The competition will be divided into *two* divisions, c.w. and phone. Each of these two divisions will be divided into *two* sections—the one-operator section, and the more-than-one-operator section. Thus there will be: (1) one-operator c.w. section and (2) more-than-one operator c.w. section; (3) one-operator phone section and (4) more-than-one-operator phone section. Stations in each section will compete for awards only with others in the same section.

C.w. stations must work c.w. stations, and phone stations must work phone stations only. However, stations in the one-operator section and in the more-than-one-operator section may contact each other as long as it is c.w. to c.w. and phone to phone. Stations may enter more than one section but separate logs must be submitted for each section.

Carroll Stegall, OQSAE, talking it over with Johnny "Skywire" Kraus, W8JK, just before leaving for the Congo.





LX1RB, owned by R. Biltgen of Esch-Sur-Alzette, Luxembourg. The rig is a 6L6 electron coupled with 30 watts input. Antenna is a half-wave Hertz. Receiver is a two-tube home-built affair. LX1RB is usually on 14375 with a T8 signal.

Competitors in sections (1) and (3) may use one transmitter only, and competitors in sections (2) and (4) may use any number of transmitters. Any number of receivers may be used by all competitors.

In order that the results may be published as soon as possible, logs must be postmarked before midnight December 15, 1939. Any logs received after this will positively not be considered.

Remember 7, 14, and 28 Mc. amateur bands are the ones to be used in the contest. Don't sell good ol' 40 too short. Usually 40 meters around this time of year is pretty good. One other word about the logs. It would be appreciated if all of the boys who take part in the contest, make sure that their logs are sent in. Even though your score is not very high it is important that it be submitted so that the ones whom you have contacted will receive credit.

Miracle

A couple of months ago I squinted into the crystal ball and came up with the prediction that by the time you were reading that issue AC4JS would be on the air. Well, it seems that my silicate sphere hit it right on the button because reports began coming in that AC4JS was on the air around 14,400 kc., and the boys in eastern USA almost collapsed the high frequency end of 14 Mc. when they actually began working him. They have been waiting a long time for that Zone 23. The next question is—"Who will be the first to send in their 40 cards for confirmation?" So far I have been able to find out that the following have worked AC4JS: W2BHW lead the parade, I think, then W1AB, W2GVZ, W2ZA, W2GRG, W2GTZ, W2JT, W2AVO, W2KM, W2ARB, W2GT, W2HHF, W2CMY, W8CRA, W8MTY and W9TB. There are of

C. W. and PHONE Z C

W9TB ...39..116
VE4RO ...38..116
W9TJ ...38..104
W4TO ...38..99
W9NRB ...38..88
G5BD ...37..113
W8BTI ...37..113
W2ZA ...37..97
W8OQF ...37..96
W2BHW ...36..105
SU1WM ...36..102
W3EPV ...36..100
W9GDH ...36..100
W9ELX ...36..88
W4FVR ...36..87
W3HXP ...36..86
W6MEK ...35..103
W5KC ...35..102
W9RBI ...35..101

1939 DX MARATHON

W2AIW .35...93
W6NLZ .35...84
W6SN .35...63
W8LFE .34...102
W3HZH .34...89
W5PJ ...34...88
K6NYD .34...83
W9GKS .34...78
G2FT ...34...76
K4FCV .33...95
W5ASG .33...85
W2IZO .33...80
W4QN ...33...79
G3AH ...33...71
W9CWV 33...70
ON4HS .32...91
W9VKF .32...86
W3FJU .32...81
W4FIJ ...32...80

W2GVZ .32...71
W6TE ...32...67
VE5ZM .31...87
W8CED .31...80
W8BWC .31...80
W1RY ...31...77
W1BGC .31...75
W9ERU .31...68
VK2EO .31...67
W6OLU .31...58
W8AU ...30...61
G2QT ...30...46

PHONE

W3LE ...34...83
W8LFE .31...84
W1HKK .31...80
W8QXT .31...78
W6ITH .31...71
F8UE ...31...71

F8VC ...31...55
W9BEU ...30...80
W6OCH .30...80
W1KJJ ...30...77
W6NNR .29...73
W1JCX ...29...72
W1AKY .29...71
W1ADM .29...64
W2AER ...29...45
ON4HS ...28...72
W2IKV ...28...68
W3FJU ...28...60
W7BVO ...28...57
K6NYD .27...63
W6EJC .27...59
W6PDB .27...59
G3DO ...26...57
CO2WM .26...55
W4DRZ ...25...62

course others, but to date I haven't run across them. Anyway, nice going, fellows, but it's a wonder you were composed enough to write us about it. If ol' QD ever landed No. 23—he'd have to suspend the column for a month.

For those who haven't heard about AC4JS, I might refer you to October issue, in which a lot of info was given by XU4XA. His frequency has been reported as being between 14410 and 14420 kc. with a T9 signal. Apparently no one on the Pacific Coast has heard AC4JS as yet. Here's hopin' though.

With the Brasspounders

As far as I know W2BHW was the first guy to land AC4JS. He heard XU8MI working him and after BMI finished he gave him a call but ND. Shortly after this brilliant failure AC4JS started calling XU4XA, and Lindy, not hearing XU4XA come back, cranked his frequency to that spot and called 4JS and nailed him OK. After Lindy pushed his heart back down his throat again he managed to make a sked for the next night. Well, from that time on the parade was under way. As usual everybody wanted to raise him next with the consequence that it was one terrific mess on the high end of 20. W2BHW has quite an impressive score in the Marathon with 36 zones and 105 countries.

W2GTZ is up to 39 and 148 with AC4JS giving Reeve one of his biggest thrills in dx'ing. W8JSU adds U3BY 14430 T7, UK6WA 14420 T6, EA5A 14405 T6, which boosts him to 112 countries. Charlie says that 8CRA is now using a 250TH driven by a 35T in his new rig. W8OQF found that FO8AC and OY4C weren't much good so has deducted them from his total, however, Ralph doesn't feel too bad about it because recent new ones give him 133 countries. The latest are VU7BR, HB1CE, 17AA and LZ11D. Ralph has totaled up his Marathon standings and finds that he has 37 zones and 96 countries since January 1st. The list looks mighty imposing with a lot of good dx being registered. W9GNU has worked a few J's, XU8MI, XU8KW but he too, found that he had one less zone than he had figured previously. Anyway, Doc now has 35 zones and 88 countries.

W9TB is another one who had a big celebration after getting AC4JS. Wally not only is up to 39 zones and 134 countries in the Honor Roll, but he has a good lead in the Marathon with 39 zones and 116 countries. Fellows, that is what I call quite a mess of dx in a period of 10 months. Other new ones for Wally are I7AA, CR6AI, MX3H. 9TB says that OY2C said he was on a tanker off the Faroes Islands—in fact, probably to the tune of 2000 or 3000 miles off because he came in on a bee line with South Africa.

W3BEN says that W3AOO ends a long and successful career of dx by getting married October 9th. And that W3EPV has just moved down the street from Ben so, er, ah, well, so from now on they will be just that much closer. Nuts. I almost forgot that W3BEN hooked OQ5AQ giving him 38 zones and 108 countries. W8CED has worked U8IB 14380, KF6OWR 14375,

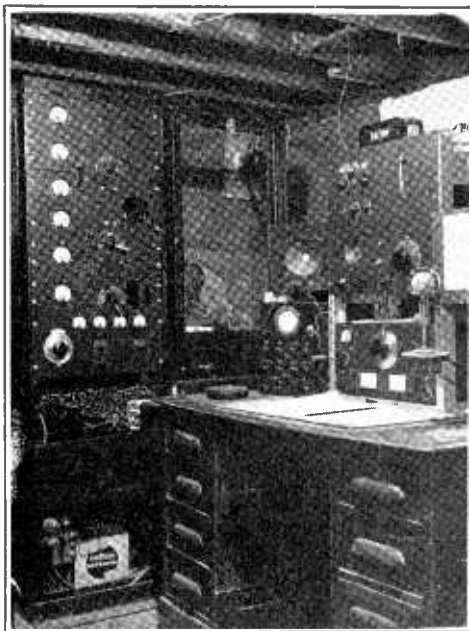

W2GRC owned by Laurence "Ben" Franklin. Transmitter uses a pair of 250TH's. Honor Roll score stands at 38 zones and 127 countries. Yes, he worked AC4JS, too.

KH6DTR 14410, and LZ11D 14435 making 33 and 97 for Lee. 8CED says that U9BC lives about 1/2 km. from U9AW and that cards for either may be sent via U9AW. U9AW often goes to 14000 kc. when U9BC is on the air because 9BC has a trf receiver and 9AW blocks it, when both are on the same end of the band. LZ11D told 8CED that he was the only legit station in Bulgaria, although in the next paragraph you will note a contradictory statement by LA2X.

Our good friend Egil Aagaard, LA2X, sends in some very fine information. Quoting Egil—"A station which we must regard as a new country is HV1PP (HVP), Vatican City. This station began operating June 10th and carried on tests for two weeks. The station is owned by the Pope and has a kilowatt output. It was built by the Chief Radio Engineer of Telefunken in Roumania, YR5BF. The antenna is a rotary beam. Most of the stations in Europe who have worked HV1PP classified him as a 'pirate' but a letter from YR5BF that he was the operator during the testing period, disproves this." If any of you fellows have worked HV1PP you may send your cards through LA2X who will be glad to forward them. In return you will receive a card from HV1PP.

LA2X says that there are a few Bulgarian stations on the 14-Mc. band and the foremost is LZ1AP, and he is considered genuine as is LZ1AK and LZ1AX. LZ1AP has 150 watts in-



O. C. Miller, XU8MI, Shanghai, China. Transmitter uses a pair of 35T's with 400 watts input.

put and uses 14385 kc. (This does not agree with what LZ1ID claims, and you will notice that no mention was made of LZ1ID by LA2X. Just what the score is we do not know but most of the gang know that LZ1ID is genuine and probably we had better treat the others with caution.) Also from LA2X, LX1RB of Ssch/Alz, Luxembourg, says in a letter that he is the only legit station on 14-Mc. c.w. His frequency is 14388 kc. and he QSL's direct. LX1RB says that LX1AZ, LX1AX and LX1AP are stations that never work 14-Mc. c.w., although there have been reports of their calls being pirated. These stations usually are on 56-Mc. fone with very low power. (Note the similarity of both LZ and LX, both adopting 1AX and 1AP. Of course these may all prove genuine later, but . . .)

G3ZC has been on 14378 kc. at St. Martins Church, Scilly Isles. OY4C has been rated as a "pirate" because none of his QSL's have an address in the Faroes and all of them have been mailed from Germany or the Netherlands. CT3AB is still active on 14365 kc. and states that a couple of "not-so-good" CT3's are on along with CT3AP and CT3AX. VU2FX who has been pounding brass in India for 9 years has left there for good. We will all remember 2FX as having given many a dx man his Indian contact. MX1A is ex-J2MJ and J3DA . . . QSL via MX3H. FT4AA, FT4AG and FT4AN is operated by the same person, and says that he has just had some cards printed and is busy "dispatching" them. His frequency is 14399 kc.

Still it comes from LA2X . . . VQ4RHL is active in Kenya and QSL's via the VQ4 bureau. I7AA is still on 14390 kc. but says not to try to QSL direct because ham work in Ethiopia is prohibited. Yes, he sends cards at regular intervals. It is interesting to note that certain Pacific stations put in swell signals in Norway—KA1FG, KA1KV, KA1KX, KA1SP, KB6ILT, KB6RSJ and KH6KKR. Those who heard YA2UR on during the early summer may as well give up because LA2X wrote him via YI2BA, as instructed, but

YI2BA had never heard of him. LA2X also wrote to FO8AC, but that was returned to him by the P.O. as "unknown." Then, too, ZX1AB operating on 14335 kc. was on board ship so that one may as well be tossed out. Egil certainly has given us a flock of good info and his cooperation is surely appreciated.

I'll repeat that RADIO has not heard of VJ2AA. A lot of the gang have worked a station signing that call and he has told you that you should "QSL via RADIO." Even though he was on St. Ambrose Island, it is not considered as a country so would not help out much.

W5KC took enough time to find out that he has worked 35 zones and 102 countries since the first of the year so the Marathon will record that accordingly. W3HZH adds a few to his Marathon score which makes him 34 and 89, while his Honor Roll totals to 38 and 139. W6MUS is a new one with us and his first figures look like 35 and 76. W6MUS is located at Coronado, California. W6TE finally landed zone 16 by working U3BM, and together with HK4DD, Bill has 34 zones and 86 countries. W9NRB says he has plenty of time to pound brass and now has added VQ2MI and VQ8AF giving him 39 zones and 98 countries. Another new one to the Honor Roll is W3EYY with his 34 and 91.

G5BD sends in his final score for the Marathon, 37 zones and 113 countries. Art said he was in hopes of finishing up near the top of the Marathon list but this thing overseas put a crimp in his ideas. Art also added a couple to his Honor Roll score in HB1CE and MX1A, giving him 39 and 133. G5BD says he hopes the world will be back on the air again before long. (He'll find a big echo to this in USA.) G3AH worked CE3CZ and K6NYD which boosts his score to 33 and 82. For the Marathon it reads 33 and 71.

XU8MI, Shanghai

XU8MI, O. C. Miller, is a U. S. Navy Radio Electrician doing a tour of duty with the 4th

U. S. Marines in Shanghai. Miller has been more or less active in ham radio since 1922, when he received his first license 9AXS, which he held until coming into the Navy. Since then he has held W3EHT and W6NHC. He first went on the air with XU8MI March 19, 1939, and his first QSO was with Lindy, W2BHW. XU8MI has 33 zones and 75 countries which is not so bad from last March. Miller expects to leave early in 1940 but would like to work all States before leaving. To date he has 39 states and needs Montana, Utah, New Mexico, South Dakota, New Hampshire, Rhode Island, Mississippi. His rig is a three stage job using a pair of Eimac 35T's in the final with about 400 watts input. Frequencies used are 14014, 14297, 14348, and 14372 kc. The antenna is a single wire fed Hertz and the receiver is an RME-69.

Miller says that although Shanghai seems like a fairly good spot to get out of, receiving conditions are pretty bad. Shanghai has been named the "city of noises," and it seems to be trying to live up to its name as far as radio interference is concerned. There are over 300 stations, broadcasting, amateur, commercial, and government, all operating without unified control. This all happens in an area two miles wide and three miles long. Combine these with all the man made noises that you will find in that congested area and you will have some idea of what he has to contend with in reception of DX signals. So, if XU8MI doesn't happen to give you a report of 599, please don't say, "That bird must have tin ears, or his receiver is lousy."

Some of the consistent c.w. signals he hears are W1AB, W1BUX, W1KHE, W2BHW, W2GTZ, W2KL, W2ARB, W2CMY, W3QT, W3GCI, W3CHE, W3WU, W4CFN, W4BPD, W4FIJ, W8GZ, W8DZS, W8MFB, W9HLF, W9DBJ, W9TJ, W9YFV, W9VDQ, W5KC, W5QL, W5EGA and a whole flock of W6 and W7. XU8MI is another who detests the way a lot of

the boys operate their e.c.o.'s. He can't understand why they insist upon getting zero beat with the station he is working and calling him before the QSO is finished. Usually Miller will ask the guy to QRX and then work him next but the deuce of it is there are some who persist in calling on every exchange. This is right in line with the way that most of us feel and I think by using common sense in operating an e.c.o. there shouldn't be any trouble. Miller wants to work as many of the gang as he can, and says that he could work more if they would use discretion in swishing their e.c.o.'s on top of the station with which he is QSO. The QRA of XU8MI is P. O. Box 685, Shanghai, China.

Newcomers to the Honor Roll

The "WAZ" Honor Roll is for the purpose of showing the dx accomplishments of the dx men throughout the world. The main portion includes the totals of both c.w. and phone contacts made by your station. The "phone" portion consists of one column set aside for the phone men only. In this section all contacts must be made with two-way phone. In other words you must raise and work the dx station with phone, and he too, must be on phone. However, the main portion of the Honor Roll actually consists of mostly c.w. work although many of them use phone also. As an example if you have worked 38 zones and 110 countries using c.w. for some and phone for others, these figures would belong in the "c.w. and phone" section of the Honor Roll. Out of these figures if you have contacted 28 zones and 75 countries using phone-to-phone, then this total would belong in the "phone" column.

To enter the Honor Roll it is necessary to send a list of zones and countries you have worked showing the call of at least one station in each. The minimum necessary to qualify is determined by the number a full page will hold. There are

[Continued on Page 93]

This famous dx man, LY1J, and his "station house." The pole at the right is painted red and white, and is about 60 feet high. The antenna is an end-fed 8JK. The transmitter now in use at LY1J consists of a 6F6-p.p. 6L6C-p.p. T-125's, with 400 watts input. On phone he grid modulates and runs about 200 watts.

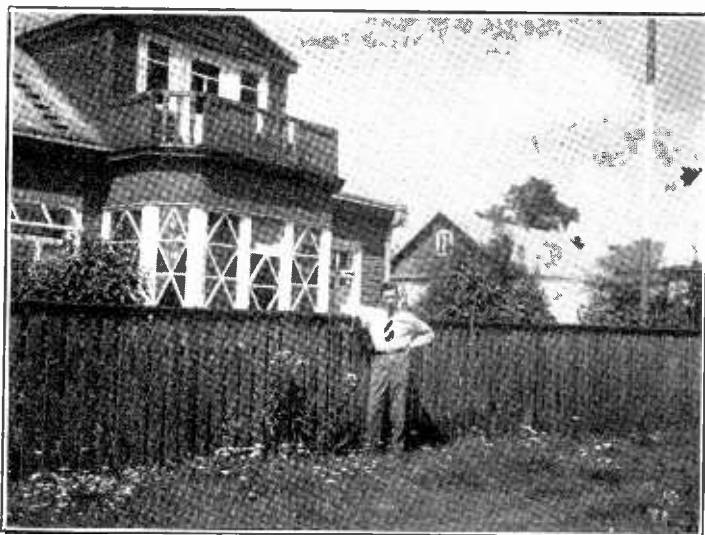

A Simple

PERCENTAGE MODULATION INDICATOR

By R. C. HIGGY, * W8LFE

A description of a simple instrument which should find use in almost every amateur phone station—an inexpensive unit combining the functions of phone monitor, carrier shift meter, and modulation indicator. In addition, since the unit can be made portable, it can be taken from the shack and used as a field strength indicator in making antenna adjustments.

Modulation percentage indicators of many types have been described in amateur literature in recent years. The majority of these indicators are complicated, expensive to build and not easily constructed with the consequent result that amateur phone stations are not as well equipped with satisfactory instruments as they should be.

The existing regulations are not too clear as to just what is required in the way of a modulation indicator and not infrequently

we find a simple carrier shift indicator that is supposed to indicate overmodulation. This instrument is also used as a "field strength meter" on occasions when one wants to make some measurements on the antenna or radiated signal. Such an instrument is really a poor modulation indicator and certainly has misled a good many operators. Needless to say the signal must be badly overmodulated to move this type of indicator.

It is quite possible that an increase in average carrier level with overmodulation can be offset by a lowering of input level under periods of high modulation where a power source of poor regulation is used. Cases have been checked where under heavy modulation the class B modulator took enough power from the power line to lower the line

* 2032 Indianola Ave., Columbus, Ohio.

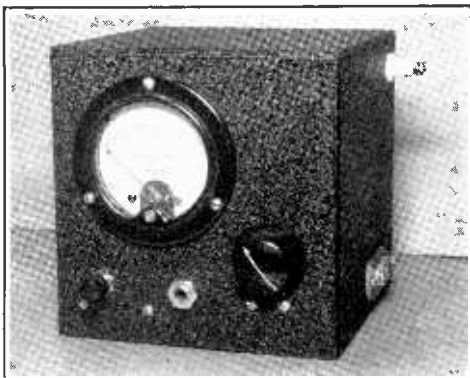

Front view of the neat box that contains the combined phone monitor, carrier-shift indicator, and modulation indicator.

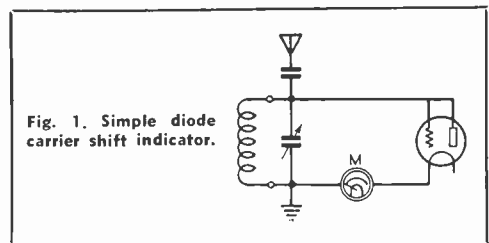
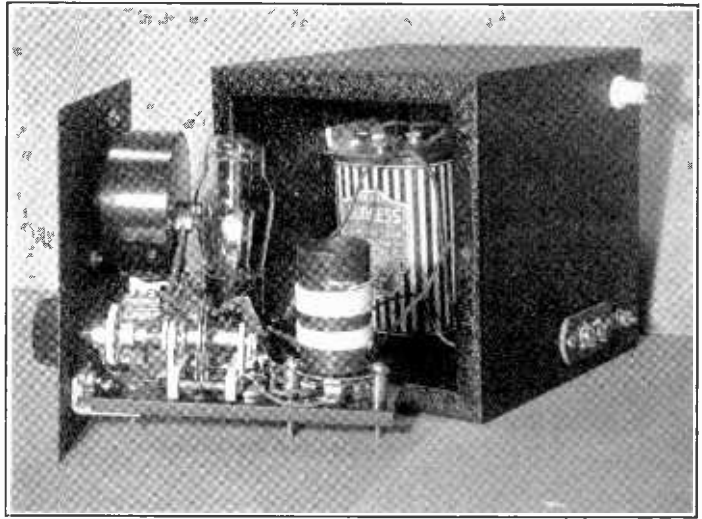

Fig. 1. Simple diode carrier shift indicator.



View showing the meter removed from its mounting box.

voltage which in turn lowered the plate voltage on the modulated class C stage and reduced the average carrier level. A carrier shift indicator would not indicate an upward shift of the carrier until positive peaks of modulation exceeded 125 per cent.

The Circuit

A simple rectifier type "field strength meter" can be easily changed at little expense so it will indicate percentage modulation without altering its usefulness for antenna measurements. A copper oxide meter unit and a few small resistors and condensers are all that will be required. Figure 1 shows the usual indicator frequently found in use at amateur stations. Figure 2 shows the revised circuit including the audio indicator circuit. An audio voltage is developed across resistor R_1 and is rectified by the separate copper oxide meter unit for the 0-1 milliammeter M . This meter will move upward with modulation to indicate percentage modulation. With the switch in the C position the meter will read the rectified d.c. carrier current just as it formerly did.

In use, observations of audio (with switch in A position) should always be made with the same rectified current in the diode circuit. It is convenient to adjust the size of R_2 so that with a mid-scale indication in the C position 100 per cent modulation will be indicated by mid-scale deflection of the meter with the meter switch in the A position. The value of resistor R_2 may have to be changed somewhat depending upon the resistance of

your meter. It will usually be between 30 and 50 ohms for most 0-1 millimeters. There is no reason why different scale meters cannot be used either. From a 0-200 microammeter to a 0-5 milliammeter have been used satisfactorily, the higher current meters requiring a little closer coupling to the antenna or transmitter to get mid-scale deflections.

[Continued on Page 82]

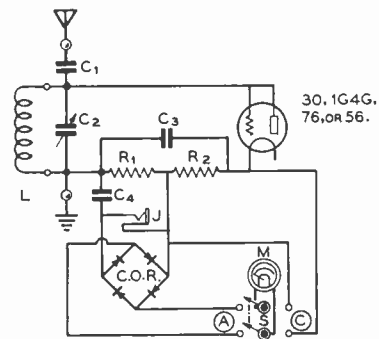

Figure 2. Wiring diagram of the simple carrier-shift meter modulation indicator.

- C_1 —0001- μ fd. mica
- C_2 —35- μ fd. midget variable
- C_3 —001- μ fd. mica
- C_4 —0.1- μ fd. 400-volt tubular
- R_1 —5000 ohms, $\frac{1}{2}$ watt
- R_2 —30 ohms, see text
- L—Plug-in coil to resonate to desired band
- C.O.R.—Miniature copper-oxide rectifier
- J—Phone monitor jack
- M—D.c. microammeter or low-range milliammeter
- S—Carrier-shift to modulation indication switch ..



By E. H. CONKLIN, W9BNX *

28 MC.

Contacts with Europe and Africa have returned on schedule, diminished by the conflict in Europe. W6's are getting into the east again. Summer short skip has about disappeared, though during the five-meter opening on October 7, W5AJG reported short skip, long skip and dx all at once on 10. From the looks of things, we may have to confine most of our dx to South America until the war is over!

W1LPO in Rhode Island, on 29,822 Mc., is willing to help those in need of a contact with that state.

W9QDA mentions reception of W2's during an aurora display early in October. The signals were fading and were accompanied by considerable noise with the antenna pointed east (direct) or north, but fading cleared up and noise dropped, though the signal strength was not quite as good, when the antenna was directed west or south.

56 MC.

Again nearly everyone had given up thought of dx on five meters, in view of the complete absence of "skip" for a month, when October 7 came along. W5AJG had been off for five weeks, then got on at 5 p.m. Central time to work W3DBC BZJ EEN W8RUE and to hear W2HWX W8NQO. Signals were steady and of good strength for an hour. Short and long skip appeared on ten meters during this time. Leroy will be on five meters all winter looking for these occasional openings.

W9ARN in Bartonville, Illinois, noticed the short skip on ten and put out a CQ on five at 6:47 p.m., raising W4FPC in St. Petersburg, Florida, turning him over to W9RGH in Peoria. W9ZHB in Zearing, Illinois, also worked FPC.

* ex W9FM, Associate Editor, RADIO, Wheaton, Illinois.

W9ZJB in Kansas City noticed that ten was acting funny with all districts coming in at four p.m. Several rapidly fading signals were heard on five meters, one a station saying, "in Los Angeles standing by." At 6:55 p.m., W4's in Georgia, Alabama and Tennessee came through so ZJB again switched to five with his beam southeast, to hear W4FPC saying that three W9's were coming through, W9ARN RGH ZJB (ZHB?), trying to make it a three-way.

W9SQE in Chicago says that he also heard W4FPC working W9VHG in Glenview.

It will be seen that all of this work was at a distance close to the one-hop E layer limit of 1200 miles or so. Apparently the ionization of the layer was just barely sufficient to bend five meter signals down.

Other Skip DX Comments

Reports collected by W1DEI, student of predictions, indicate that 56 Mc. opened on September 2, but on no other date that month. The next open day, it seems, was October 7. A recheck of DEI's data removes dates listed last month as possibly open on E layer dx: April 24, 27; May 22; June 21; July 10, 20, 26; August 5. The work on the morning of May 7 was W1 to W9; that on August 4 was W1 to W4. August 6 brought reports of W1 working VE3, W4 and W9, with W2 also working W4 and W9. August 8 was open three hours between W1 and W9.

Frank South, W3AIR, is commuting from Princeton to his work in New York, so time on 56 Mc. is limited to long evenings except week-ends (ahem!). He gives us the following calls-heard list: May 8: W4EDD DRZ. May 15: W9EMF SQE MIW ARN ANA. May 16: W4EDD FBH DRZ FLH FQC. May 24: W4EDD DRZ. May 28: W9BQY LAS USI. May 29: W9AHZ. June 4: W4EDD FLH. June 5: W4EDD. June 7: W5AJG DXB. June 8: W9ZJB AHZ ZD. June 9: W4DRZ W9NIW ARN CBJ AHZ ZHB VHG SQE FEN GHW TCX SMM USI W8CVQ. June 12: W4DRZ W9AHZ LF ZD CBJ TPI CLA EMF FBH OLY SQE UOV. June 13: W4EDD DRZ. June 27: W4EBQ W8AGE. July 13: W9AHZ. July 27: W4AUU DRZ EDD W5AJG W4FBH W6QLZ W9ZHZ GHW. July 31: W9ZHB WDA ARN USI ZJB CBJ HIC PQH HZQ.

From Atlanta, W4FBH asks us to "use our influence" for some winter band openings. We did what we could on October 7, but FBH did not get in on it.

Speaking of dx, VK2PS on July 9 was listening to a ZL telling a K6 that five meter signals from Hawaii had been logged in New Zealand. We have no idea as to the possible accuracy of the report.

DX Predictions

At his own expense, W1DEI is sending monthly bulletins to a selected list of stations, arranging tests for days of predicted band openings. Mel says that big days for W1 to W9 work are likely to be 27 days apart.

The sporadic-E layer data of the National Bureau of Standards for August appeared in the October issue of the *Proceedings* of the I.R.E. The general pattern of band openings agrees with the reflection observed hourly at Washington, although there were hours on several days that should have been good, on which we received no reports of dx, particularly August 5, 6, 16, 17, 19, 23. Following that there was a week with no sporadic-E reflections at all and no dx. September measurements will be published in the November issue of the *Proceedings*, showing vertical reflections beyond 8 Mc. only at 7 p.m. on September 26, beyond 6 Mc. at 5 p.m. on the 17th, and out to 4.5 Mc. on only ten other hours (Eastern time), during the month. It is no wonder that skip dx fell off to nothing.

Pre-Skip DX

W9ARN in Bartonville, Illinois, has been holding nightly schedules with W9ZHB in Zearing, sixty miles away, since March. Signals are always 100 per cent with variable degrees of fading. Others around Peoria include W9RGH GAO GIE NJX, and W9CBJ in Washburn. He does not feel that 200 mile distances over Illinois will be possible but is anxious to find more stations at 100 miles or more to work. W9DQH is trying to influence fellows at the University of Illinois at Urbana, about 90 miles away. We saw George Lang, W9CLH, late in September and urged him to get on more; now W9ARN says that he has joined morning and evening schedules with W9BHT ARN ZBH RGH, putting in a consistent signal from east of Elgin.

W3AIR says that he has heard considerable dx out to 300 miles during the summer, but longer skip seemed prevalent.

W8NBV in Erie uses his concentric-line-tuned acorn receiver to pull in low power c.w. transmitters 125 to 200 miles away, and some other dx signals that always use phone and have not been identified.

W1JFF recalls 1931 when he had 112A's in a five-meter rig that gave a thrill when a distance of six to ten miles was worked. He urges us to try to create interest in local contacts of 30 to 50 miles—he understands that W1 and W2 both have trouble with inactivity when the dx is off. He is afraid that he is the only one in Rhode Island left

on the band. It seems that he should be able to break in on the 10 p.m. W1DEI-W2AMJ schedule.

With only fifty watts, W1DEI in Natick, Mass., is holding nightly schedules with W2AMJ in Bergenfield, N. J. Mel uses a 16 element beam 60 feet high, but Frank has only a vertical extended double zepp. The distance is about 200 miles.

We should like to receive more reports of this pre-skip, or semi-dx of the low atmosphere bending type. Such mention will make it possible to find stations at distances of 100 to 300 miles with which tests might be arranged. It is largely through such work that a high degree of efficiency is obtained and the real possibilities of equipment on this band discovered. Another thing, although we hear about beams on sixty foot towers, out

**56 Mc. DX
HONOR ROLL**

Call	D	S	Call	D	S
W9ZJB	9	18	W4DRZ	6*	
W3AIR	8	24	W6QLZ	6	
W3BZJ	8		W80JF	6	
W3RL	8	24	W9AHZ	6	
W5AJC	8*	27	W9NY	6	13
W8CIR	8*		W1JMT	5	9
W8JLQ	8		W1JRY	5	
W8VO	8		W1LFI	5	
W9ARN	8	15	W2GHV	5	8
W1EYM	8		W3GLV	5	
W9ZHB	7		W3HJT	5	
W2AMJ	7	22	W6DNS	5	
W2JCY	7		W6KTI	5	
W3BYF	7		W8EQJ	5	10
W3EZM	7	24	W8OPO	5	8
W3HJO	7		W8PK	5	
W4EDD	7		W8RVT	5	7
W4FBH	7	19	W9UOC	5	8
W5CSU	7		VE3ADO	4*	
W5EHM	7		W1JNX	4	
W8CVQ	7		W3FPL	4	8
W8QDU	7		W6IOJ	4*	
W9CLH	7		W8AGU	4	
W9SQE	7		W8NOB	4	
W9USI	7	16	W8NOR	4	7
W9VHC	7*		W8NYD	4*	
W9WAL	7		W9QCY	4	7
W9ZUL	7	11	W1KHL	3	
W1DEI	6	18	W6AVR	3	4
W1VFF	6	11	W6OIN	3	3
W1LLL	6	17	W7GBI	3	4
W2LAH	6		W8OEP	3	
W2MO	6	20	W8OKC	3	6

* plus Canada. (reported in 1939)

Note: D—Districts; S—States

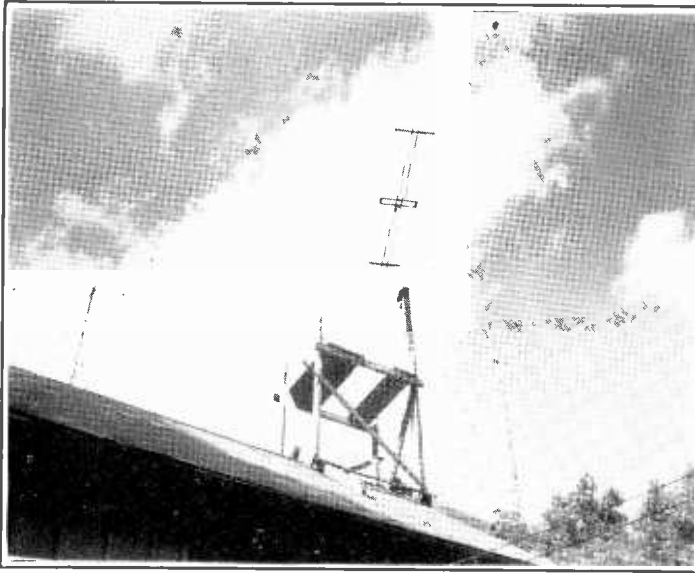

The three-element quarter-wave spacing array used on 56 Mc. at W9ARN, Bartonville, Illinois.

our way not even the Century Club dx men go that high on twenty meter antennas. The art of tower building and raising has become a lost one since spark and 250 meter days. How about a little dope on tower construction and raising, perhaps including drawings? We look longingly at some of these scaffold towers obtainable in large cities for construction and cleaning work—particularly these solid ladder-like structures that can be raised some sixty feet by turning a crank. What a spot to build and tune a beam!

Equipment

Perhaps the absence of pre-skip dx in Illinois over distances comparable with that east of Detroit is due to some inherent differences in the desire of individuals to experiment with antennas, feeders, and receivers. One should not expect general coverage commercial receivers to turn out dx signals in the same way as will a specialized receiver with high 56 Mc. sensitivity (signal-to-noise ratio, not over-all gain including i.f. and audio).

Let's get to work on the *first two stages* in our receivers (r.f. and mixer) and improve the non-regenerative stage gain. Let's see that the transmission line from the antenna is matched properly to the r.f. grid circuit. Don't forget that transmission lines on five meters are long in terms of wavelength, and should be constructed efficiently of spaced open wire or air-dielectric copper tubing concentric line. The antenna itself presents a broader

problem. Some, like W8QDU, W8VO and W2AMJ, prefer a high non-directional stacked antenna while others will try to get more gain out of multi-element beams placed as high as possible. Tuned feeders have several disadvantages, one of which is the difficulty of resonating a primary coil in a receiver and adjusting the coupling for satisfactory transfer of energy.

W9SQE finds that it is possible to use concentric lines twenty inches long with such tubes as 1852, and 6K8. He finds that the lines are a large improvement over the old coils, even with these tubes which have a low input resistance, only several thousand ohms, which is shunted across the tuned circuit. His oscillator is a 6J5, as we recall, with a small coil in the cathode and the concentric line in the grid, the plate being untuned.

W9ZJB now has 400 watts on a pair of HK54's, but his best news is the purchase of two acres of land about ten miles north of Kansas City, a "prize location," at the peak of a hill, altitude about 1,200 feet. He made a test between two manufactured 5 & 10 receivers, finding one as stable and sensitive as the other was disappointing. So don't put too much faith in any one component on five meters—test them all carefully before assuming that they are the last word.

For both skip and pre-skip dx, W9ARN has been using a three-element horizontal antenna. The reflector and director are spaced

[Continued on Page 86]

A BETTER SKY CHAMPION THAN EVER BEFORE!



At no increase in price!

Though the price of raw materials has advanced in recent months, Hallicrafters manufacturing technique has more than kept pace. Consequently, it was possible either to reduce the price of the Sky Champion or to bring out a greatly improved model at the old price of \$49.50.

Mr. Halligan decided that it would be in keeping with the Hallicrafters policy to produce the finest communications receiver possible to sell just below \$50.00. It is the *new* S20R Sky Champion.

It has all the fine features of the former model *plus these quality additions*: 1 Additional Stage of I.F. (2 I.F. Stages in all); 1 Additional Tube (making 9 tubes in all); Dickert Automatic Noise Limiter; Separate Electrical Band Spread—Inertia Controlled; Drift-Compensated High Frequency Oscillator; 3 Watts output; *Both* Dials Illuminated.

Of course it retains all the essential features of the former model such as a Stage of Pre-Selection; Sponge Mounted Speaker; Beat Frequency Oscillator; Continuous Coverage from 545 kc to 44 mc, etc.

Your purchases of Hallicrafters equipment in such enormous quantities has made this great receiver value possible. It is in the nature of a dividend from the largest builders of amateur communications equipment.

the hallicrafters inc.

CHICAGO, U. S. A.

"LARGEST BUILDERS OF AMATEUR COMMUNICATIONS EQUIPMENT"

POSTSCRIPTS...

and Announcements

WOE UNTO THE "BOOTLEGGER"

Lester B. Bentley, Max Pross and Louis D. Welsh, all of Kokomo, Indiana, have been convicted in the Federal District Court, at Indianapolis, Indiana, on charges of operating an unlicensed radio station in the amateur bands. All three men were also convicted of operating the station without operator's licenses. Indictments were secured against each of the three defendants. They were arrested and upon arraignment in the District Court, they all entered pleas of guilty. The Court fined each defendant.

Egan Stickles and Howard W. Crandall, both of Bradford, Pennsylvania, were recently convicted in the Federal District Court, of Erie, Pennsylvania, on charges of operating an unlicensed amateur radio station. Egan Stickles was also convicted of operating the station without an operator's license. Both men plead guilty and were placed on probation for two years. They were also required to pay the costs of the trial.

*A
Very Merry
Christmas
To You from
The Staff
of "Radio"*

"V. F."

For some inexplicable reason, amateurs refer to any oscillator used for transmitter control as an "e.c." when it does not use a quartz crystal. Many such oscillators are not actually Dow electron coupled oscillators, and therefore all non-crystal oscillators or exciters used for transmitter control shall henceforth be referred to in general as *V.F.* (variable frequency) oscillators or exciters. This is quite logical, because while all electron-coupled oscillators may be considered of the variable frequency type, not all variable frequency oscillators are electron coupled.

"Rig here uses a V.F. exciter. Etc. What are you using o.m.?"

BRITISH SITUATION

A letter dated early in October, from Miss Nelly Corry, G2YL, gives us the story on the present status of the Radio Society of Great Britain, and the British amateur.

The society has decided to carry on with their magazine, "*T & R Bulletin*," at least for the present. The G's, however, find it hard with every bit of gear taken away except the receiver, "for safe custody, for and on behalf of his Majesty!" A little listening, on ten meters, revealed no signals from Europe or Asia, though W's were heard working a few Scandinavian and Italian stations. K6 and KA came through together with 26 South African stations and OQ5AB and OQ5AE. The majority were working the U. S. A. while ZS2AH said that he had 387 W contacts in ten days.



W1ACV sends in the above snapshot taken on a Bridgeport, Conn. street. He says that the driver wasn't around, hence couldn't be asked if he was a ham.

Merry Christmas

BURGESS

BATTERY COMPANY

FREEPORT, ILLINOIS

NEW BOOKS

and trade literature

CATHODE MODULATION, by Frank C. Jones. Published by Pacific Radio Publishing Co., Inc., Monadnock Building, San Francisco, California. Retail price, \$1.00 per copy.

Cathode Modulation is a complete treatise devoted to a system of cathode modulation perfected by Frank C. Jones after extensive research. Briefly, it allows modulation of high power output by means of a small, inexpensive modulator. A single 6F6, for example, modulates a 25-watt carrier, and a pair of 809 triodes modulate up to 600 watts of carrier output.

Cathode Modulation describes how to design, build and operate radiotelephone transmitters from the smallest to the largest. The chapter on theory is readily understandable by the layman. The circuit diagrams and photographs are large and clear. This new book should appeal to every amateur or commercial radiotelephone designer, experimenter, engineer and constructor. The subject is refreshingly new, holds untold possibilities, and promises to be a major contribution to the development of radiotelephony.

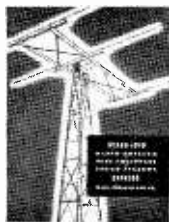

NEW SEARS CATALOG

Sears, Roebuck and Co. have released their new 1940 radio catalog, in which is listed a large line of amateur, p.a., and service equipment. All items listed in the catalog are available on time payments.

A postcard to Sears Personal Service Department requesting catalog R8132-D (mailed to any Sears mail order store) will bring a copy.

sonal Service Department requesting catalog R8132-D (mailed to any Sears mail order store) will bring a copy.

NEW CORNELL-DUBILIER CATALOG

The Cornell-Dubilier Electric Corporation has recently issued a new 1939-40 sixteen page edition of its catalog, Radio Capacitors for all Requirements. Listed as No. 175-A in the series, this catalog deals with Mica, Paper, Dykanol, Wet and Dry Electrolytics for Amateurs and servicemen and gives a complete description and listing of the Cornell-Dubilier Capacitor Test Instruments and Quietone Interference Filters. Many new types of capacitors recently developed in the Cornell-Dubilier laboratories are described for the first time in this catalog. A copy of Catalog No. 175-A can be obtained free on request at all Cornell-Dubilier distributors or on application to

the main office of the Cornell-Dubilier Electric Corporation, South Plainfield, N. J.

WARD'S AMATEUR CATALOG

Ward's new amateur radio catalog, containing nationally advertised items, is available on request. Everything in the catalog may be purchased on Ward's time payment plan. Address requests for this 1940 catalog to Montgomery Ward, Dept. AW31, Chicago, Ill.

AEROVOX 1940 CATALOG

Aerovox has just published its new 1940 general catalog covering resistors, test instruments, and all types of condensers. This 28 page catalog is available to readers of *Radio* upon request to The Aerovox Corp., New Bedford, Mass.

NEW BLILEY CATALOG

Available upon application is a new Bliley catalog number G-11. The new catalog covers general communication frequency crystals, holders, and oven for frequencies between 20 kilocycles and 30 megacycles. Amateur crystals are not listed in this publication.

Catalog G-11 should be of considerable interest to radio engineers and others interested in the application of quartz crystals for transmitter frequency control, for use in filters or for special optical and electrical applications.

• • •

Although most cathode-ray tubes use a screen surfacing of medium-persistence green, there are also special surface screens available for other particular uses.

For phenomena which change with extreme rapidity, there is the short-persistence blue screen. For transient phenomena, there are screens which will hold a single sweep for as long as sixty seconds, permitting easy photographing and/or the placing of several patterns on the screen at one time for the purpose of comparison. There is also a medium-persistence white screen, which gives a black-and-white pattern especially suitable for television images and certain other types of work.

What's New

IN RADIO

NEW TURNER DYNAMIC MIKE

The Turner Co. of Cedar Rapids, Iowa, is offering the trade a new Dynamic Microphone, Model 33D, which has a 25 foot "balanced line" cable set. This improvement permits the operation of the microphone under noisy circuit conditions. This new model is full satin chrome finished, in streamline style. It is ruggedly built for recording or p.a. work, and withstands bad climatic conditions and reasonably rough handling. The head tilts over full 90° range, allowing semi-directional operation. Long lines of 100 feet are possible with high impedance unit, and thousands of feet with low impedance. It has an output level of -54 db at high impedance, and a range of 40-9000 cycles without peaks to cause feedback. This Turner Model 33D is furnished in 50 ohms, in 200 or 500 ohms, or in high impedance.

HALLICRAFTERS SKYRIDER "DEFIANT"

The latest Hallicrafters receiver—the Skyrider "Defiant" SX-24—offers to amateurs and others of modest circumstances a communications set which incorporates substantially all modern, practical developments plus some advanced features.

Electrical bandspread has been brought to such a degree of perfection, for instance, that the bandspread dial is calibrated directly in frequency for the amateur ranges from 10 to 80 meters, with the conventional 0-100 division calibration for use in other commercial and short-wave bandspread ranges. Tuning drift is so reduced by means of temperature compensated tuning circuits that in the 10-meter amateur range for example it does not exceed 2 kc. during a test period of one hour and from a cold start.

Other features of the "Defiant" include: four selectivity positions—broad, sharp, crystal phone, and crystal c. w.; signal-strength meter calibrated in "S" units and db, automatic noise limiter, continuous coverage from 540 kc. to 43.5 Mc., crystal filter, beat-frequency oscillator with pitch control, tone control, provision for remote standby switching, built-in power supply for 115-volt a.c. operation and provision for operation from batteries or vibrator supply.

SCRATCHI sent us the following postcard: "Dear Hon. Ed.—Very sorry not having time for writing yoosal f.b. letter as are being in roots from E. Shroudsburg, Pu. See me coming in super special January issue."

Nine tubes are employed as follows: 6SK7 r.f., 6K8 oscillator-mixer, 6SK7's in two i. f. stages, 6SQ7 detector-a.v.c.-first audio, 6F6G output, 6H6 automatic noise limiter, 76 b.f.o. and 80 rectifier. The cabinet is finished in gray crackle with contrasting black controls and satin finish stainless steel trim.

BROWNING FREQUENCY STANDARD



To meet the demand for an accurate inexpensive 100-1000 kc. frequency standard, the Browning Laboratories has announced the Browning Frequency Generator. It incorporates extremely stable 100-1000 kc. oscillators which can readily and independently be set to their respective frequencies by zero beating against WWV's standard frequency. The accuracy of setting these oscillators against WWV is at least 1 part in 200,000. Either audio modulation or a pure RF signal may be obtained and the amplitude of either varied by means of an attenuator. A mixer tube is incorporated so that signal generators, oscillators, exciters, transmitters, etc., may be accurately checked at 100 kc. intervals by the zero beat method without auxiliary apparatus. The accuracy of the check points is better than 1 part in 40,000. The apparatus is available either in kit form or laboratory built.

LOW-LOSS MICA CONDENSERS

The Aerovox Corporation of New Bedford, Mass., is offering low-loss yellow bakelite molded mica transmitting condensers at 25 cents above usual list prices for standard brown bakelite types. This line also includes meter mounting brackets to take the standard molded mica condenser, for shunting meter windings.

NEW "MOBILE" MIKE

Universal Microphone Co., Inglewood, Cal., is now distributing a new model of its Police
[Continued on Page 86]

STANCOR

GENERAL UTILITY AMPLIFIERS

FOR DRIVER, MODULATOR and
PUBLIC ADDRESS SYSTEMS



STANCOR

THE scientific advancements contained in Stancor's 1940 line are attracting the attention of the entire industry. We illustrate a few here with brief descriptions. All are more fully illustrated and described in the new 1940 Stancor Hamanual now available upon request at your jobbers. Ask for a copy.

STANCOR 415 AMPLIFIER KIT—Two channel electronic mixing, three inputs, dual tone control, 2A3's in 15 watt Class AB power amplifier. Net price less accessories **\$31⁵⁰**

STANCOR 430 AMPLIFIER KIT—Two channel electronic mixing, three inputs, dual tone control, 6L6's in 30 watt Class AB1 power amplifier. Net price less accessories **\$33⁵⁰**

STANCOR 460 AMPLIFIER KIT—Two channel electronic mixing, three inputs, dual tone control, 6L6G's in 60 watt Class AB2 power amplifier. Net price less accessories **\$37⁰⁰**

Get Your

STANCOR HAMANUAL

Free . . . At Your Jobber

This Fourth Edition thoroughly describes a host of new Transmitters and Amplifiers. Write us for dealer's name.

**STANDARD TRANSFORMER
CORPORATION**

1500 NORTH HALSTED STREET, CHICAGO

The Open Forum

Chevy Chase, Maryland

Sirs:

At the meeting of the Washington Radio Club on October 14th, 1939, a "Code of Conduct" was adopted unanimously. This code, in many respects, is similar to the code of conduct adopted by the newspapers during the World War, which established for the press, at its own suggestion and under its control, a censorship more rigid than that which might have been established by the Government. The Washington Radio Club in adopting this "Code of Conduct" is extending to the 46,000 other amateurs in the United States an invitation to join in additional self-policing, which goes beyond the present treaties, laws, and regulations regarding amateur radio operation to an extent which may prevent the shutting down of our stations.

Wide publicity in the local papers is being given to the "Code of Conduct" which was adopted by the members of the Washington Radio Club so that it may, to a certain extent, off-set the detrimental effects of articles written by certain ill-informed newspaper columnists.

Roy C. Corderman, W3ZD
Chairman Publicity Committee,
Washington Radio Club

WASHINGTON RADIO CLUB Special Wartime Code of Conduct For the Radio Amateur

The Washington Radio Club, recognizing that the continuation of Amateur Radio in the United States during the present international situation depends on compliance with all international treaties, laws of the United States and regulations pertaining to radio, especially with respect to neutrality, additionally proposes for the consideration of all radio amateurs the following Code of Conduct:

1. Confine all *international* contacts strictly to discussions of experiments and small talk.
2. Avoid reference to anything which may have possible military significance.
3. Transmit no information of an un-neutral nature.
4. Refrain from expressing over the air personal views of international events.

5. Use no foreign language or code.

6. Caution all amateurs who are observed violating any of the foregoing.

Winnipeg, Man.

Sirs:

I think I have every Handbook you have published and while I have never written you before, I might as well take this opportunity to say that I think you're giving the "hams" just the right stuff. However, what I have to say is this: Looking over your 5th edition, page 42, you discuss "The Vacuum Tube as an Amplifier" and in the second column—third line down—you say: "Thus, it can be seen that the grid acts as a valve in its control of the plate current; it is for this reason that vacuum tubes are termed valves in Britain, Australia and Canada." Now, I believe you are correct in saying that Britain and Australia use the term "valve" for what is known on this continent as "tube", but frankly if I walked into any radio store in Canada and asked for a valve I am quite positive they would direct me to the nearest plumbing supply house! No, tubes are tubes in Canada, not valves.

Now, I realize this astounding bit of information isn't going to throw the sun off its beaten path, and I hope you will take the above in the friendly spirit it is given. It only goes to prove once more just how closely Canada and the United States are knit together. Your terms are ours, and vice versa.

As you no doubt know, all Canadian hams have been off the air since Canada declared war on Germany. However, I imagine the sale of Handbooks would be about the same for I know there is an awful lot of studying going on, where before everyone was so very busy working other hams they didn't have the time. Another thing I think will be found interesting: When this war is over you will find most Canadian hams mighty fine operators. Since licenses were cancelled there are all kinds of classes going on—turning out speedier operators, and this has no connection with the army either. The boys just like the idea. Personally I have boosted my copying up to 25 w.p.m. where before it was around 18, and I mean to hit 35 before I'll feel satisfied.

R. C. ANDREWS, VE4VH

RESULTS OF THE 1939 INTERNATIONAL DX CONTESTS ESTABLISH THESE SIX IMPORTANT FACTS

47%

1. of all the DX phone (VE & W) winning contestants use *Eimac* tubes.

2. Two of the three highest scores in the CW Contest and all three highest scores in the Phone Contest use *Eimac* tubes. (As listed in Oct. QST).

42%

3. of all the DX c. w. (VE & W) winning contestants use *Eimac* tubes.

4. Tubes with tantalum plates are far superior when it comes to actual performance. First, second and third winners and four out of seven of the entire list of winners used tubes with tantalum plates.
5. Eimac tubes are first choice by the majority of the leading amateurs. Five of the first six winners and five out of every eleven of the winning (VE & W) list use *Eimac* tubes.
6. Six out of every ten of the (W) sectional winners, as listed in October QST, used tantalum plate tubes and *Eimac* tubes lead the field in this group five to one.

The fact that 44% of all the winning amateurs in the phone and CW contests use *Eimac* Tubes should indicate to you that ... where performance and dependability are a factor ... *Eimac* Tubes are first choice. (See lists in your October QST.)

Eimac
TUBES

Eitel-McCullough, Inc.
San Bruno, California

YARN *of the* MONTH

COMPANY

Dinner is over, the dishes are washed, and the junior op. is tucked in for the night. The o.m. and x.y.l., who also holds a ham ticket, have repaired to the shack and are all set for an enjoyable evening of ragchewing and pursuing dx.

"Ahhh," sighs the chief op. as he eases his six-feet-odd into the most comfortable chair in the room, turns on the receiver and the transmitter filaments, and proceeds slowly to tune over the band.

The x.y.l. removes an audio choke, a transformer which the o.m. started to rewind and didn't finish, a HANDBOOK, three copies of RADIO, a coil form and a spool of solder from the chair with the least on it, and seats herself.

"Mmmmm," mumbles the o.m. as he lights a cigarette, "Swell night!"

Then he lapses into a profound silence and devotes his entire attention to the business of tuning. Finally the x.y.l. snickers. "You look like a fish out of water with your mouth open like that. Aren't you afraid that a stray fly might . . . ?"

"Quiet!", the o.m. growls as he listens more intently.

It is dx, calling CQ, and as the station signs and the o.m. is reaching for the switch the doorbell rings loudly.

"Front door," he indicates with apprehension, "you answer."

"I can't," wails his better half, "I've simply got to comb my hair. I'm a mess!"

"Yah," derides the o.m., "But that's nature's fault and there's nothing you can do about it. Answer the door!"

An argument ensues during which the second op. scurries off, frantically searching for a comb. The o.m. stomps down stairs, his face set in a grim smile.

The front door opens. Then, "Hello, Casanova!" (Which nickname the o.m. had discarded along with other school day follies.)

"You old son-of-a-gun. Haven't seen you since we used to play hookey from school. You're looking older. Heh, heh! Yes siree, Cass, (the x.y.l. can almost hear the o.m. gnashing his teeth) "the old rocking chair's getting you."

"Meet the girl friend. Just thought we'd drop around for a pleasant visit with you and the ball-and-chain (very jovially) Haw, haw. Don't believe I've ever met her, by the way. Got your address from Bill. Hope you weren't thinking of going out," (As though it mattered.)

The x.y.l. decides to let the combing go and rushes down stairs, thinking that she'd better rescue the arrivals while the o.m. struggles with his feelings.

Standing just inside the "welcome" sign are an obnoxiously exuberant young man, whose name it seems is Tommy, and a fluffy, giggling, sweet young thing. Following introductions, during which the o.m. manages to regain something of his composure, everyone goes into the living room. There they sit, all smiling broadly, and all wondering what to say next.

The o.m., still thinking about the elusive dx which was rolling in, finally in desperation suggests that they all visit the shack and see the rig. He gets a couple of blank stares, although Tommy and the sweet-young-thing try hard to look intelligent. After an explanation, succeeded by a chorus of "Oh's" they troop upstairs.

The x.y.l. cleans off the remaining chairs by dumping their contents onto the floor, and everyone sits down. The visitors, looking incredulous, are trying to see everything at once, and are looking very impressed about the whole thing.

"Ooooh, what's this?" gurgles the sweet-young-thing, picking up a brand-new 35T from the table where the o.m. had reverently placed it, and dangling it upside down between two fingers.



THIS IS AN ACTUAL PHOTO TAKEN ON MY SHIPPING TABLE OF SOME OF THE MODELS ALWAYS IN STOCK

Write me fully about type of receiver you want. I will help you get the right receiver and will see that you are 100% satisfied. We stock all receivers—more than 25 models of all makes—and know all about them. Ask for technical information about any receivers.

YOU can buy on 6% terms financed by myself so you buy with less cost—more convenience—quicker delivery.

YOU get maximum trade-in for your receiver—describe it and I will tell you its trade-in value—and can pay the balance on my 6% terms.

YOU get ten days' free trial—you don't buy unless you are satisfied.

YOU get prompt shipment from the world's most complete stock of amateur receivers. Shipment from factory if you wish.

I have a complete stock of all amateur receivers, transmitters, kits, antennas, tubes, parts, etc. so send to me for any equipment in any catalog or ad and I guarantee you can't buy for less or on better terms elsewhere. Your inquiries and orders invited.

Bob Henry
W9ARA

HENRY RADIO SHOP

The x.y.l. gasps; the o.m. turns green. Springing into action, he gently but firmly rescues the tube, lovingly stows it in a drawer, and mops his brow.

Tommy suggests getting on the air, "or whatever you call it." The o.m. turns on the rig and speaks into the mike. The raucous chatter of the "class B's" indicates that something is placing an undue load on the modulators. The o.m. mutters and glares at the defenseless meters, then snatches up the neon bulb and gets down to business. After a few minutes of probing, the x.y.l. notices that a feeder wire has become shorted and passes on the information. After that has been fixed the rig is again in working order.

A local ham is heard calling CQ. The sweet-young-thing looks entranced and wants

to know if he looks much like Tyrone Power. The o.m. guffaws, thinking about local ham's figure, age, and five children, and gives him a call. Local ham comes back with a "Well-what-do-you want?" attitude indicating that he was probably looking for dx. The x.y.l. takes over the mike to soothe his ruffled feelings and explains that there is a *very* pretty y.l. just dying to talk to him. The s.y.t. gingerly approaches the mike as if she's afraid it might bite (it does a little, but it's just stray r.f.) and stammers, "Hello, how's the weather out there?" The x.y.l. snorts and the o.m. hastily explains (in a tone one would use to a three-year-old) that the l.h. just lives three blocks away, and that presumably the weather is the same as it is here. The s.y.t. looks a bit embarrassed and giggles.

Then it is Tommy's turn. Looking as though he were about to make an after dinner speech, he steps up to the mike, clears his throat loudly and says, "Well, well, well! Well, . . . er . . . a . . ." (in an aside that modulates the rig to about the 75 per cent level) . . . what do you call this bird? Well hullo, old man . . . ah . . . great thing this radio, yes sir! And to think that Casanova here . . ." The o.m., slightly pink about the ears, and hoping that the l.h. didn't catch that last remark, grabs Tommy's place and tells local ham he'll let him get away to work some dx. Then he signs.

The sweet-young-thing laments, "Aw, aren't we going to talk any more? It's fun."

The o.m. decides he'll call CQ. He does, but the s.y.t. has started chattering about something and Tommy is telling the x.y.l. a few choice yarns about himself and the o.m. when they went to school together, and the QRM in the shack makes the QRM in the band sound like the gentle murmur of rustling leaves. The o.m. sits with his jaw set, and tunes ever-so-carefully over the band. But the two visitors have vocal powers that could

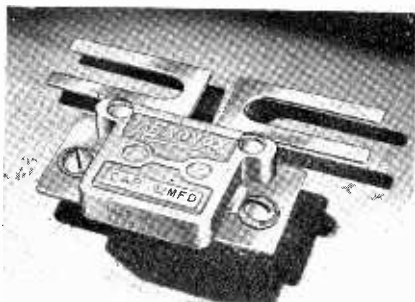

A Choice in
Mica
CONDENSERS

● Bakelite-molded condensers with meter-mounting brackets permitting r.f. shunting of meter windings, have just been added to the already remarkably complete line of AEROVOX mica condensers. Likewise the option of low-loss or mica bakelite (yellow finish) units in any type, at slight additional cost.

To you as a builder of radio transmitters and receivers, this wider choice in mica condensers is not to be overlooked.

New CATALOG . . .

Ask local jobber for our new 1939-40 catalog containing many new items. Or write us direct.



DYNAMIC MICROPHONE

D8

AMERICAN built quality into the D8. List Price

\$22.50

Also, adjustable yoke permits nondirectional or semidirectional pick-up.

Plug at microphone for quick cable attachment; **D8T**, 200 Ohm, 500 Ohm, or High Impedance. **\$25.00.**

Licensed by ERPI. Request Spec. Bulletin No. 33.

AMERICAN MICROPHONE CO., Inc.
1915 S. Western Ave., Los Angeles, Calif.



out-talk any class AB 6F6's that were ever made.

After a few more of the o.m.'s unsuccessful CQ's, the x.y.l. decides that judging by the dark red surging up the back of the o.m.'s neck the guests would be safer elsewhere, and she suggests that they all go downstairs for some refreshments.

Several cups of coffee and two plates of sandwiches later, Tommy says that they hate to leave but they really must. Also that they will come back *real* soon and often, and thanks for the lovely evening. At last the door closes.

"Grrrr," shudders the o.m., "and it was such a good night. All that dx rolling in!"

"Never mind," says the shack-cleaner-upper. "They meant well. Maybe the dx is still coming in."

With one accord they turn and go up to the shack. The o.m. hears a nice juicy bit of dx calling CQ. He calls the dx. He stands by and back comes the dx . . . to another local ham! The o.m. gets up and stomps about on the remains of a neon tube he had dropped a few minutes before. The x.y.l. decides it's time for bed and as she passes through the door, "Good night . . . Casanova!"

She ducks adroitly as a 5Z3 hurtles over her head.

Comes the Revolution

[Continued from Page 15]

by adjusting the carrier axis so that it is one third the A-E distance from axis E, instead of the usual value of one half the distance, we can obtain an effective power increase of 2 times. Yet we have only about half as much carrier and about three quarters as much input. This is assuming that the output is limited by the plate dissipation of the tubes, which is usually the case with efficiency modulation.

The only difficulty with this system is that the 200 per cent modulation in a positive direction, with resultant mean modulation percentage of 150 per cent, is in violation of the present F.C.C. ruling. It looks quite promising but will have to wait. Let's see what we can do and still comply with the letter of the law.

If we lower the carrier from the halfway mark until point P_3 corresponds to 133 per cent positive modulation, then we are still inside the law. A picture of this condition (not shown) would be somewhere between that of frame 1 and that of frame 2, resembling frame 1 more than frame 2. The carrier efficiency would be 34.5 per cent, the

**For Amateur
Radio Hardware
See
MALLORY-YAXLEY**

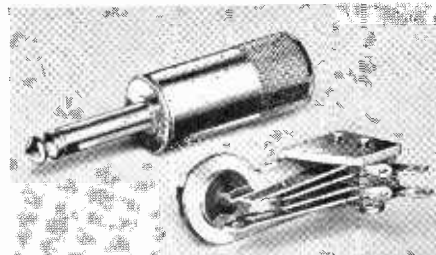

Two-way phone plug No. 75N, with shielded nickel shell. Other types—three-way, tie cord, etc.—in both bakelite and nickel shells.

Junior Jack No. 704—springs are parallel to panel for compactness—thirteen combinations available in this type.

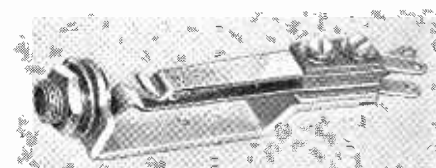

This three circuit microphone jack No. 2B is typical of the famous Mallory-Yaxley Line. A variety of spring combinations is available for practically any application and special models can be furnished on order.

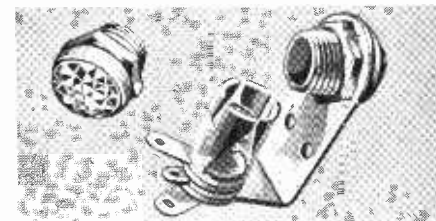

Avoid run down batteries, or increased power bills by using Mallory-Yaxley Pilot Lights and Jewels as indicators. They will keep you "informed" at all times, and enhance the appearance of your rig.

P. R. MALLORY & CO., Inc.
INDIANAPOLIS INDIANA
Cable Address—PELMALLO

Use

P. R. MALLORY & CO. Inc.

MALLORY

APPROVED RADIO
PRECISION PRODUCTS

Use

YAXLEY

APPROVED RADIO
PRECISION PRODUCTS

input 430 watts, the carrier power and plate dissipation just a little less than for frame 1. The trouble is that the increase in sideband power is only 14 per cent. This is better than frame 1 and perfectly legal, but certainly not nearly so gratifying as operation under the conditions depicted by frame 2.

We can get more sideband power than this and still comply with the letter of the law by observing the operating conditions shown in frame 3. The sideband power will be as great as that in frame 2; but the input will be twice as much, the carrier power four times as great, and the tube dissipation

somewhat higher. Ironically, while this condition complies with the F.C.C. ruling (the mean modulation percentage is only 75 per cent), it will produce four times as much heterodyne interference as the same transmitter operating as in frame 2 and delivering the same sideband power.

Obviously it is possible in one article only to scratch the surface of anything so far reaching in its aspects as extended positive peak modulation for voice work. Succeeding articles in RADIO will cover all phases of the subject quite thoroughly.

The "One Sixty"
[Continued from Page 32]

voltage varies more than 2 or 3 volts at full modulation, a regulator should be incorporated for maximum stability. Such a regulator (VR-150-30) costs but little more than the 8- μ fd. electrolytic condenser (C_5) it eliminates. Besides providing good voltage regulation for the oscillator, it is virtually as effective a ripple filter as the electrolytic condenser. When incorporating a VR-150-30 it is necessary to observe polarity the same as for an electrolytic condenser.

If the unit is to be used for 40- and 20-meter operation, it will be necessary to substitute a good vernier type dial for the regular dial shown in the photograph. This is necessary because the dial must cover 2000 kc. on 160 meters and this represents 16,000 kc. on 20 meters. A reduction ratio of at least five to one and a micrometer type scale are highly desirable for 20- and 40-meter operation.

While not necessary for 160-meter work, it is recommended that the exciter unit be mounted on small pieces of live sponge rubber for high frequency operation.

See Buyer's Guide, page 98, for parts list.



Just Out!
**RADIO
SERVICE
TRADE
KINKS**

A quick-reference manual of radio set troubles and their repair.

By Lewis S. Simon, Manager, Rexall Radio Stores, Brooklyn, N. Y. 269 pages. 9x11, spiral-bound to open flat, \$3.00.

This is one service manual it will pay you to use. It gives blunt, step-by-step directions for finding troubles and for fixing them. Some of the methods are homely trade kinks that have never before been known except to a few expert service men. Every trouble solution has been checked again and again. Every page of directions may be depended upon.

**Shows Weaknesses and Key Trouble
Spots of Specific Sets**

The book points out the weak points of radio receivers of specific makes and models, and consequently enables you to go right to that point to spot the trouble. It saves you going through elaborate tests of the entire circuit. It will save you hours of time and give you satisfied customers.

**Covers Hundreds of Makes and Models of
Receivers, Household and Auto**

SEE IT 10 DAYS — SEND THIS COUPON

McGraw-Hill Book Co., 330 W. 42nd St., N. Y. C.

Send me Simon's Radio Service Trade Kinks for 10 days' examination on approval. In 10 days I will send \$3.00, plus few cents postage or return book postpaid. (We pay postage on orders accompanied by remittance.)

Name
Address
City and State
Position
Company R.12-39
(Books sent on approval in U.S. and Canada only.)

Here's Something Hot!

CATHODE MODULATION? Yesir!—That rik of yours can be converted into a CATHODE MODULATED 'PHONE JOB in a hurry—and only for the price of a single inexpensive transformer and a few small parts. Modulation for a kilowatt will cost less than a single tube for the final RF stage. New Kenyon CATHO-DRIVE transformers, especially designed for this type of service, have universal type secondaries that match any cathode circuit from 40 to 3000 ohms. Take a look at these prices—then order now from this ad. CATHO-DRIVE units are IN STOCK NOW!

TYPE	Max. Sec.	Audio Tubes	NET
T-471	200 MA	Single 6F6	\$2.40
T-472	300 MA	PP 6V6 or 2A3	3.00
T-473	450 MA	PP 6L6 AB ₁ or AB ₂	3.60

ALLIED RADIO CORP.
833 W. JACKSON BLVD. Dept. 14-M-O, CHICAGO

Reducing Splatter in Phone Xmitters
[Continued from Page 34]

magnitude of the reactance into which the tubes are operating.

If the minimum plate current and maximum grid current points come at the same setting of the plate tank condenser when the amplifier is unloaded but do not when the stage is loaded, it means that the stage is being loaded too heavily for the Q of the tank circuit or that the antenna system is coupling a reactance into the tank. The remedy is either to use a higher Q plate tank or to retune the antenna and feeder system to resonance, or both.

Back Coupling as a Cause of Phase Modulation

Another condition which can cause phase modulation as the transmitter is amplitude modulated is coupling from the modulated output of the transmitter back to one of the exciter stages. This can occur when there is inductive coupling from the output tank circuit or the antenna feeders to the tank coil of one of the exciter stages which is operating on the output frequency. This

back coupling can cause a phase shift in the grid excitation to the modulated stage. The phase shift would be proportional to the amount of energy which is being fed back, and since the amount of energy in the output circuit would be proportional to the modulation, the phase of the energy appearing at the grids of the modulated stage would vary with modulation. Phase modulation arising from this condition can cause the same undue sideband width or splatter as phase modulation arising from any of the other sources.

The cure for this condition would simply be to shield the exciter stages from the modulated output circuits of the transmitter. In this way the back coupling will be stopped and any phase modulation arising from it will be eliminated.

It is hoped that this article, calling to the attention of the amateurs a condition that could cause that difficult-to-locate source of sideband splatter, will be influential in reducing the sideband width of transmitters which are conscientiously "modulated less than 100 per cent" and yet are guilty of spurious sidebands.

BINDER FOR RADIO MAGAZINES

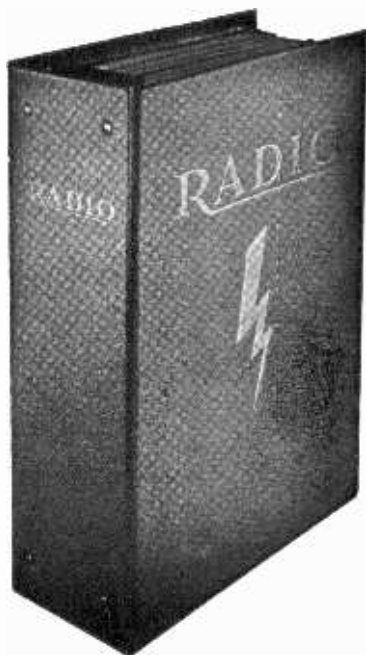

Sturdy and convenient, this handsome binder holds a year's copies of "Radio"—your big "Radio" Handbook—and one smaller book by The Editors of RADIO!

Beautiful, red imitation leather richly embossed in gold, each book or magazine may be inserted or removed at will. As our supply is limited, we suggest that you order yours—TODAY.

• **\$1.50 Continental U.S.A. \$1.65 Elsewhere**
 (Postage prepaid by us.)

THE EDITORS OF
RADIO *technical publishers*

1300 Kenwood Road, Santa Barbara
 CALIFORNIA

quality above all
SOLAR
TRANSMITTING CAPACITORS



TRANSOIL—Oil-filled capacitors for permanent filters; superior stability over widest temperature ranges; surge-proof construction; separable mounting bands: "Quality Above All!"

Ask for free No. 10 Catalog; buy from your local Jobber

SOLAR MFG. CORP.
 Bayonne, New Jersey

YOU'LL HAVE A FINER RIG WITH WARDS PARTS AND EQUIPMENT

You'll be amazed at the array of nationally advertised Amateur equipment—one of the most complete stocks in existence—now offered by WARDS. And remember, every part and accessory bears the unqualified approval of well-known Radio Engineers, who pronounce them the greatest value on the market today. Thus you can now build a finer outfit, or improve the performance of your present set.

New Amateur Catalog Saves You Money

- Take Advantage of WARDS
- Convenient
- Time Payments
- 15-Day Trial
- Money-Back Guarantee

Send for WARDS new Amateur Catalog at once! Use it for selecting receivers, transmitters, mikes, keys, parts—anything you need in radio or sound system work. Note how it makes it easy to compare testing instruments. And especially, note the money-saving prices on everything. It's FREE. Just mail the coupon.

MONTGOMERY WARD

9 Great Mail Order Houses
 More Than 600 Retail Stores



Montgomery Ward & Co.
 Dept. AW-32, Chicago, Ill.

Please RUSH to me at once your new Amateur Radio Catalog.

Name
 Address
 City State

RADIO

Series Cathode Modulation

[Continued from Page 28]

precaution is not observed it is very likely that a number of shorted by-pass and filter condensers in the speech amplifier will be the result. Also, make quite sure that the chassis of the modulated amplifier is grounded to negative high voltage. The filament by-pass condensers for the modulated tubes should be returned to the chassis of the amplifier.

See Buyer's Guide, page 98, for parts list.

FIGURE IT OUT YOURSELF!

One of the Editors is quite wacky where statistics are concerned. His latest revelation is that each page of the new 1940 Radio Handbook costs you only \$00.00234375! 640 pages, not counting the cover!

Duo Power Modulator

[Continued from Page 23]

ing to solder them down. Plan a place for each resistor and condenser, and run your wires in such a manner as to do a neat job. It always pays to spend a reasonable amount of time on this work before starting to clip and solder wires.

In placing the leads carrying the high voltage, cover them with good grade spaghetti, as the plate leads particularly develop remarkably high peak voltages. Sockets and plugs number 2 and 3 should be of ceramic material, and be sure to use rubber grommets of ample size where all of the high voltage leads go through the chassis. These points are from plug no. 3 to socket no. 3 and to the plates of the 809's, and from socket no. 3 to the secondary of the output transformer. These latter connections should be available from the back of the chassis.

Here is a tip which will be well worth remembering. In using one of the metal cased Weston meters mounted in a metal panel, which is of course grounded, certain precautions are necessary to keep from burning out the meter.

Investigation showed that the case is grounded to the permanent magnet inside the case through the small case retaining screws. To blow the meter it is only necessary to make the needle, which is hot, hit the pin on either end of the scale. This we must avoid. Two steps can be taken that will insulate the movement from the case. The first one is to drill new holes about 1/4 inch away from each of the little case retaining screws. Tap these holes for no. 2 screws, which should be fitted before removing the original screws. Then remove the case and install bumpers made from one strand of a piece of stranded push back wire at each end of the scale. Form a loop at one end to fit under the screw that

holds the dial in place, and turn up the other end as a bumper. Make the angle sharp. Slip over this turned up end a piece of very small spaghetti, and your bumper is complete. Repeat for the other side and replace the cover.

Now, though the needle is hot, and though the insulation between the movement and the magnet is not too good, the case is no longer grounded to the magnet because of the new case screws. They are tapped into the bakelite base and the original screws are left out. It saves a lot of trouble, of course, to use one of the newer bakelite cased meters, but many of us have the older type and hate to throw them away. It is not always possible, or even desirable to place the meters in the cathode circuits, though it would be an alternative solution in most cases.

As a suggestion, it appears that this 100 watts of audio equipment might be used to modulate a kilowatt by the cathode modulation method. All of which gives me an idea for putting to work that HK354 which has been lying idle on the shelf, awaiting a modulator.

See Buyer's Guide, page 98, for parts list.

Cathode Modulation Operating Data

[Continued from Page 18]

Overmodulation Indication

Regardless of whether conventional or extended positive peak modulation is contemplated, an overmodulation indicator that works off the *Negative* peaks is recommended. The instrument should be of the half-wave type.

TYPICAL DESIGN EXAMPLE

As an example of how a cathode modulated amplifier is designed from the foregoing data, suppose we take the push pull 812 amplifier described last month. 812's provide high plate dissipation per dollar, and this unit makes an excellent cathode modulated amplifier. Simply remove the ground from the filament center tap, reduce R to 250 ohms, and the circuit can easily be arranged as in figure 2.

The maximum I.C.A.S. plate voltage rating for c.w. is 1500 volts; hence we shall use that plate voltage in order to secure maximum efficiency.

The plate tank spacing should be twice this voltage, or 3000 volts. Such a condenser was specified in the article on the 812 amplifier.

As the μ is 29, three times cutoff bias at 1500 plate volts is 155 volts. Therefore the total bias should be at least this amount.



**Centralab
UNIVERSAL
SPLIT-KNURL
CONTROL**

Sh! It's a dank dark secret . . . known only to several thousand service men . . . it takes a special shaft to fit the knobs on many of the new (1938-39-40) sets.

So, instead of tearing your heart out thinking up new cuss words, get in touch with your nearest Centralab jobber for a Universal Split-Knurl control with the shaft that cuts as easily as butter. Shaft is brass—3 3/8" long from mounting surface. For switch type and Midget Radiohm switch covers K155, K156, K157, or K158.

**Be sure
You
Say
Centralab**



CENTRALAB

Div. of Globe-Union Inc.
Milwaukee, Wisc.



The "Radio" Antenna Handbook

The best factory-built "superhet" won't drag in much without an antenna, but with a good antenna it is possible to hear the world on a one-tube set. That's why everything worth telling about antennas can be found in the 100 page "Radio" Antenna Handbook. The foremost work on this subject, it is revised regularly. Easy-to-understand, this book contains material found in no "general" handbook. Chapters on Noise Reducing Receiving Antennas. Feeders of all types; Practical Arrays and Directive Antennas combined with many diagrams, table of dimensions for all frequencies (no calculations necessary), and illustrations, this book is the only one of its kind published.

75c In Continental U.S.A. Elsewhere **85c**

THE EDITORS OF **RADIO** 1300 Kenwood Road, Santa Barbara, Calif.

RADIO

The plate input will be 2.2 times the plate dissipation for the two tubes (55 watts each I.C.A.S. rating), or 242 watts.

The plate current will be 242 watts divided by 1500 volts, or 0.162 amp. (162 ma.).

The r.f. driver should be capable of delivering 5 per cent of 242 watts, or 11 watts.

The audio power required will be one-tenth of 242 watts, or 24 watts.

The cathode impedance will be one-tenth of the plate impedance, or 925 ohms. A 1000 ohm tap on the transformer will give virtually an exact match.

The bias tap should be approximately 0.4 the impedance of whatever tap is used for the tap C. Thus "B" should be connected to the tap closest to 400 ohms.

The grid leak resistance can be determined by multiplying the minimum permissible bias (155 volts) by 2 and subtracting the fixed bias (45 volts), which will leave 265 volts. Assuming 10 ma. per tube (medium-small, high μ), the grid current will be around 20 ma. Hence the grid resistor should be the closest stock size to 13,250 ohms (265 divided by .020). The resistor should be provided with about 5 taps to give additional resistances in the neighborhood of 12,000, 10,000, 8000, 6500, and 5000 ohms.

SERIES CATHODE MODULATION

The foregoing data applies to the type of cathode modulation in which the audio power is introduced into the cathode circuit by means of a modulation transformer, as in figures 1 and 2. In the Dawley system of series cathode modulation, described on page 24, neither modulation transformer, bias supply, nor speech power supply is required, but the design factors are considerably more involved. For this reason, no general design data is given for this type of modulation.

Aural Compensation

[Continued from Page 51]

are both heterodyning with the beat frequency oscillator. The system shown in figure 1 has been in service for some time in a receiver built by the author and provides base boost or bass attenuation, treble boost or treble attenuation in an infinite number of steps through the use of the two potentiometers.

In considering the theory of operation of this circuit, three important facts should be brought to mind:

1. The resistances of R_1 , R_2 , and R_3 are practically constant at all audio frequencies.
2. Inductive reactance is proportional to frequency, therefore the reactance of the coil

L will be low at low frequencies and high at high frequencies.

3. Capacitive reactance is inversely proportional to frequency. This means that the reactance of condenser C is high at low frequencies but is small at high frequencies.

Suppose, now, that we remove the grid leak of a resistance-coupled stage and insert the resistors R_1 , R_2 , and R_3 as shown in figure 2. The signal voltage is applied across a sort of voltage divider made up of R_1 in series with R_2 and R_3 . The grid, being connected at point A, is energized by $\frac{1}{4}$ of this voltage, the other $\frac{3}{4}$ appearing as a voltage drop across R_1 .

Next, let us connect inductance L between the upper line and the moving arm on R_2 . With this arm at the bottom of R_2 low frequency signals will be shunted to ground with resultant bass attenuation. With the arm at the top of R_2 the low frequencies will be bypassed around R_1 to the grid with resulting bass accentuation. By placing the moving arm near the midpoint of R_2 the normal low frequency response of the amplifier will be obtained.

Treble control is accomplished in a similar manner by placing the condenser C between the upper line and the rotor of R_3 . High frequencies will be attenuated by moving the contact toward the grounded end of R_3 and

can be increased in level by turning the arm toward the grid end.

The values shown in figure 1 may be altered to suit individual requirements. The value chosen for R_1 determines the degree of treble or bass boost when the potentiometer arms are in the upper position, a higher value emphasizing the boost but at the same time increasing the insertion loss and thus decreasing the overall gain of the amplifier. The 10 henry choke and the .0025 microfarad condenser are resonant at approximately 1000 cycles per second. Of course the circuit Q is very poor because of the resistors. However when both potentiometer arms are at the ground position, sufficient peaking is obtained to be of help in the crowded c.w. bands.

Figure 3 shows how the system may be adapted to a transformer coupled stage. Parallel plate feed is employed through resistor R_c .

There is no reason why the amateur with a phone rig should not incorporate this control system in his speech input amplifier. Then he can cut the masking lows and the ether-cluttering highs when working the Antipodes, but when chewing the rag with some soft voiced femme he could throw in that ultra bass boost and thus bowl her over with his masculine charm.

Circular A-7 describes the complete line of Bliley Crystal Units and contains a useful amateur frequency chart. Ask your Bliley distributor for your free copy.



**PRECISION
MADE
DEPENDABLE
ACCURATE
ACTIVE**

BLILEY B5 40-METER CRYSTAL UNIT

DO YOU WANT TO LEARN WIRELESS and TELEGRAPHY?

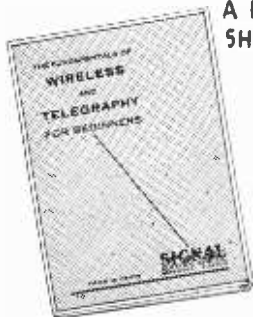

A BOOK EVERY AMATEUR
SHOULD HAVE —

Send Now!

Hundreds of amateurs have learned
from this book, so can you.

This book gives you the fundamentals of wire-
less and telegraphy. It contains the codes and
how to learn them. Mail your order now to:

SIGNAL ELECTRIC MFG. CO., Menominee, Mich.

ESTABLISHED
1892



OHMITE RESISTORS

*Proved Right
in Amateur Rigs
Everywhere!*

Be sure of continuous,
trouble-free performance
and maximum efficiency in
every stage of your trans-
mitter! Get Ohmite Vit-
reous - Enamelled "Brown
Devil" Resistors, "Divid-
ohm" Adjustable Resistors
and other Ohmite parts
from your Jobber.

Write Today for Catalog 17

OHMITE MFG. CO.

4868 Flournoy St., Chicago, U.S.A.

OHMITE

RHEOSTATS RESISTORS TAP SWITCHES

RADIO

The Amateur Newcomer

[Continued from Page 61]

Calibration

In making the original adjustment some means of calibration must be available so that the instrument may be properly adjusted to read percentage modulation. Either an oscilloscope or another instrument of known accuracy may be used to read percentage modulation. The meter shown in the illustration has plug-in coils for different phone bands and calibration was made in comparison with a percentage modulation meter in use at a regular broadcast station. A big coil was made to tune near the broadcast station frequency and the instrument was set up alongside the station's modulation monitor. Then R_2 was adjusted until center scale gave 100 per cent modulation with rectified carrier current set at mid scale. However, for most amateurs an oscilloscope or a vacuum-tube peak voltmeter can be used to make the calibration adjustment. A trapezoidal pattern indication on the oscilloscope will be found to give the best indication of 100 per cent modulation.

Limitations

This type of indicator is not an accurate peak indicator unless a special high speed meter is used. Most meters usually available are not fast enough to follow the audio envelope accurately. Hence the meter should be used with some understanding of such a limitation. This is of course true of all indicators using a meter unless the meter is of the high speed type. Nevertheless this type of indicator is very useful and a valuable addition to any station, and one can be made at little expense and labor.

Other uses for a percentage modulation indicator will quickly present themselves. It may be used to indicate the amount of hum on any supposedly unmodulated carrier and of course will provide, with a pair of phones, an audible check on any signal.

The resistors may be of 1/2-watt size and the copper-oxide unit may be one of the small meter rectifiers commonly available at supply stores. They are usually about one-half inch in diameter and are commonly used in service instruments.

See Buyer's Guide, page 98, for parts list.



HIGH Q LOOP

The specialized U.H.F. tank circuit.
Lowest loss • Most symmetrical •
No contact joints in circuit • Cir-
cular condenser plates • No metal
condenser frame • Self supporting
inductance • Pyrex condenser ad-
justment tubes. Complete 10 meter
tank circuit kit \$5.00 net.

LINDBERG MFG. CO.

658 Roscoe St. Chicago, Ill.

Control System for C.W. and Phone

[Continued from Page 52]

rier control begins to come into operation. The transformer primary, CH₁, and the condenser, C₂, filter out the pulses of rectifier audio from the 1-V and feed them to the resistor network in the grid of the keyer tubes. The value of condenser C₂ will determine the amount of lag between the time the operator stops talking and the time the carrier is cut off.

When placing the circuit into operation R₂ is adjusted just to the point where the carrier comes on with no modulation and then it is backed off a small amount. Then any audio input to the microphone will be rectified by the 1-V. If the rectified audio peaks are above the threshold level the gas in the neon bulb N will be broken down and the resulting positive voltage will be fed through S₁ to buck out the negative voltage of the bias supply. The carrier will then come on. Any extraneous noises in the room will not operate the transmitter, providing the threshold control is properly set, due to the action of the neon bulb which only will pass signals above a critical level which ionizes the gas in the bulb.

When the circuit is properly adjusted it is only necessary to press the key to turn on the carrier at any time. However, when switch S₁ is closed the carrier will also come on whenever the microphone is spoken into; either method of control of the carrier or both may be had as desired.

Choosing the Swinging Choke

[Continued from Page 39]

no-load impedance is found by dividing our 2000 volts by the current taken by the bleeder

alone or $\frac{2000}{0.05 \text{ amp.}} = 40,000 \text{ ohms.}$ Substituting this value in our L_{max} formula gives us 40 henries.

Thus, if we can find a 550-ma. choke with an inductance of not less than 40 hy. at 50 ma. or 8 hy. at 550 ma., we can use 2000-volt condensers. If we find that the choke will not swing that high, we must use 3500-volt condensers. A thumbing through the catalogs showed a 500-ma. 8-17 henry choke to be a common item. This would mean using the 3500-volt condensers, but the 866's are fully protected from excessive peak current. The L_{max} computations are worth-while making also, for in many cases it will be possible to effect substantial savings when buying condensers simply by using a bigger choke, two chokes in series, or a lower resistance bleeder in order to achieve L_{max} > No Load Impedance

1000

KENYON QUALITY SWEEPS COUNTRY

JOBBER EVERYWHERE SWING TO
AMERICA'S FASTEST SELLING TRANSFORMERS



Wherever you go — Amateurs are talking about KENYON TRANSFORMERS. Long recognized for their outstanding quality . . . it was somehow thought that KENYONS were expensive.

BUT THE TRUTH IS OUT! Dollar for dollar . . . measured by *on-the-air-service hours*. KENYON TRANSFORMERS are your best buy. No wonder Amateurs demand them . . . no wonder jobbers everywhere are stocking KENYON to take care of this insistent and growing demand.

YOU CAN NOW BUY KENYON AT

- W5ATB Radio Inc. Tulsa, Okla.
- W9ECY Auto Equipment, Denver, Colo.
- W5EVD Beam Radio Co., Little Rock, Ark.
- W3BE C. E. Electric Supply Corp. Washington, D.C.
- W9GFQ Wholesale Radio Labs., Council Bluffs, Iowa
- W6ITW Radio Supply Inc., Salt Lake City, Utah
- W7EIW Spokane Radio, Spokane, Wash.
- W7FNS Stubbs Electric Co., Portland, Ore. Wholesale Radio Service, Modesto, Calif.
- W6LR Dow Radio Supply Co., Pasadena, Calif.

ASK THESE MEN WHY KENYONS ARE SUPERIOR IN EVERY WAY!

BE WISE—KENYONIZE



**KENYON
TRANSFORMER CO., INC.**
840 BARRY STREET • NEW YORK, N. Y.
Expert Department: 25 Warren St., New York, N. Y.

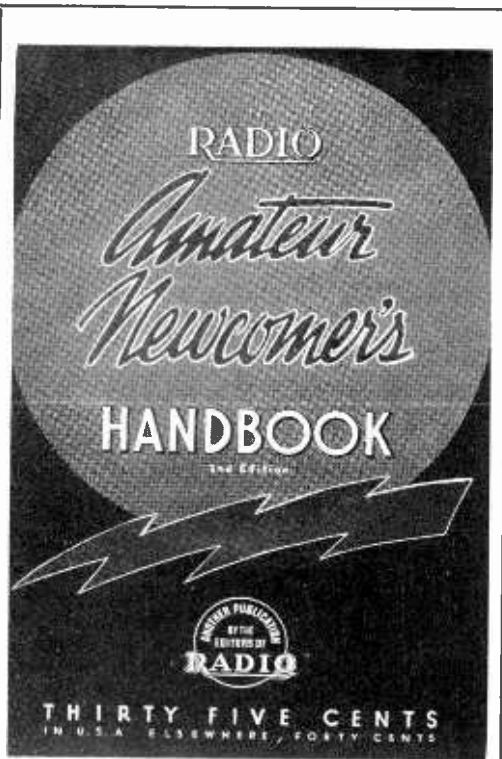

Just Out!

Really two complete books under one cover, the big, new "Radio" Amateur Newcomer's Handbook contains everything needed to obtain a license and get on the air.

Easy-to-understand data on elementary radio theory (simplified), radio laws and regulations; how to learn the code; how to pass the amateur examination (including questions and answers); detailed construction data on simple receivers; a low-powered c.w. transmitter; and a beginners phone transmitter.

Place an order with your local dealer or write direct to us.

35c U.S.A. (including possessions) Elsewhere **40c**

THE EDITORS OF
RADIO 1300 Kenwood Road,
Santa Barbara, Calif.

RADIO

"Pidgee"

[Continued from Page 38]

a ground was handy it was attached and it seemed to raise the reports at the listener end of the contact about one R. Naturally, a long aerial and good ground make for good results; but so far most any piece of wire strung up in the air has given results. After all, Pidgee was built for fun and is operated in the same spirit. The transmitter as described is a copy of one built by W9JUG.

See Buyer's Guide, page 98, for parts list.

Inexpensive D.C. Relays

[Continued from Page 43]

can as one side of the coil circuit. Connection can then be made by a piece of spring bearing against the can as it is plugged in.

If the vibrator has five prongs, the can of course may be left floating. If it is not desired to use the radio chassis as the ground lead to the coil, insulate the spring and glue a circle of fibre to the chassis so the can will not contact it.

A type A synchronous vibrator will have six prongs and this procedure will not be necessary. Remove the leads to the prongs from two opposite fixed contacts and parallel the contacts internally. Use these extra prongs as desired.

If the relay is to be used to carry very heavy current, install heavier leads from the contacts to the prongs.

The conversion of a type B vibrator is similar, requiring insulation of the reed and internal removal of the wire which connects between the hot side of the coil and one fixed contact. When the reed is insulated, it automatically removes the connection between itself and the ground side of the coil.

In both types, if a S.P.D.T. relay is desired, bend the back contact over until it touches the reed contact in its normal off

ALL YOUR RADIO NEEDS

Here in this one big book you will find everything you need in radio

- ... sets, parts and supplies
- ... public address systems ... amateur equipment ... testers and kits ...
- ... all of your nationally known favorites at lowest possible prices. Best of all, our service is better than ever ... most orders are shipped same day they are received. Write now for your copy of this valuable book. Do it today.

FREE CATALOG PROMPT SERVICE ALWAYS

BURSTEIN-APPLEBEE COMPANY
1012-14 MCGEE STREET, KANSAS CITY, MO.

position; otherwise bend it out of the way. Bend the make contact until the full on position of the reed is such that it makes good contact with it.

A type A relay generally has a resistance between 10 and 15 ohms and six volts D.C. on them continuously causes overheating. At three volts they run perfectly cool and draw but 200 to 250 mills. This voltage can be obtained from a six volt battery by inserting a one or two watt resistor equal to the coil resistance in series with the coil when wiring the socket.

The type B relay resistance generally runs higher, on the order of 25 to 50 ohms. Such relays seldom require a series resistor. Current again is around 250 ma. It is suggested that the coil resistance of each type be measured.

Because of the construction of the coil, 6 volt a.c. operation causes the reed to vibrate. It is possible to rectify 110 a.c. (full wave) and drop the voltage but since the cost of parts would nullify the savings, it is suggested for fixed station operation that a storage battery or dry cells be used. A type A relay will operate for approximately 300 intermittent operating hours on two 30c dry cells without the series resistor, and the type B on four. In average operation, this

means a life of a year or more. Other methods of obtaining d.c. from the transmitter have already been described in this magazine.*

It must be understood that these converted relays are suitable only for light and medium duty, in which the current controlled is within the capacity of the internal connecting leads. They may be used only in circuits in which inductive kickback will not arc across the points. Usually a .01- μ f.d. condenser in series with a 1/2 watt, 1,000 ohm resistor across the points will eliminate such arcing. They must not be used in circuits in which the voltage is higher than the type of insulation in the relay will stand. Our experience shows 400 to 500 volts to be the safe limit. If these conditions are fulfilled, their operation will be perfect.

We have, in fact, used converted vibrators in 10-meter mobile transmitters to turn on a 300-volt, 100-ma. dynamotor; as filament relays; receiver muting relay; keying relay; and in portable transmitters to transfer the power supply from transmitter to receiver and vice versa. Other applications readily suggest themselves.

*RADIO, May, 1939. Burnett: "Resurrecting the D.C. Relay," Page 52.

AN IMPORTANT INNOVATION

Antenna MATCHING NETWORK COILS

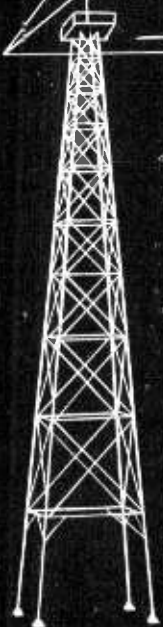

- Greatly simplifies Antenna Network construction and operation
- Plenty of taps on main windings and links
- Set of two coils permits all-band operation
- Made in 500 watt and 1 KW sizes
- Low-loss "Air-Wound" construction
- Complete data on Matching Networks supplied with each coil
- Furnished complete with mounting insulators and base

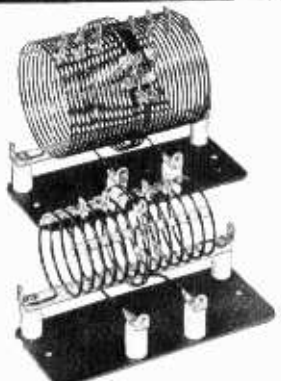

Cat. No.	Watts	Bands	Amateur Net
ACV-1	500	40-160	\$3.42
ACV-2	500	10- 20	2.64
ACM-1	1 KW	40-160	6.60
ACM-2	1 KW	10- 20	5.10

Be Sure To See These Items At Your Jobber's

BUD RADIO, INC.

CLEVELAND, OHIO

RADIO

Frequency Measurements

[Continued from Page 35]

hear harmonics with the super's oscillator on 12.44, 14, 16 and 18.67 Mc. Now suppose we assume these to be the 7th, 6th, 5th and 4th harmonics respectively. Multiplying, we get: $7 \times 12.44 = 87.08$, $6 \times 14 = 84$, $5 \times 16 = 80$, $4 \times 18.67 = 74.68$. But there must be something wrong, because they don't all give the same product. Let's try another set of multipliers: $9 \times 12.44 = 111.96$, $8 \times 14 = 112$, $7 \times 16 = 112$, $6 \times 18.67 = 112.02$. This checks pretty well, so the receiver is known to be on 112 Mc. There is only one set of consecutive multipliers which will check.

I have used all of the above methods at various times and have found them to be both accurate and convenient. I've never had to resort to lecher wires even to get the right harmonic.

What's New in Radio

[Continued from Page 68]

Special Handi-Mike, designed especially for police transmitter use. A new feature of the instrument, which has been a catalogue item for many years, is that the motor frequencies are damped out.

The Police model is a specially constructed unit mounted in a chrome handi-mike case with a ventilated rubber mouthpiece for close talking. It is the same size and weight as the regular handi-mike model and uses a single button carbon unit.

The technical features include a press-to-talk switch for relay circuit, a six foot two-conductor shielded weather-proofed cable, the shield being used as a common ground.

U. H. F.

[Continued from Page 64]

$\frac{1}{4}$ wavelength, à la W4EDD, increasing the radiation resistance of the antenna and making the tuning less critical. This wider separation for closely spaced antenna elements should be used more widely on the highest frequency bands where the spacing can be obtained readily without too large a structure. ARN uses Q bars to match his feeder to the antenna. He needs only a W7 contact, having heard only one 14 Mc. code harmonic from that district.

Some interesting antenna tests have been made at W1DEI. Different antennas show up best for skip at varying distances (that is, for signals coming in at different vertical angles above the horizon). When the band is wide open, his twelve element beam 60 feet high is best but when it is just opening or closing, some stacked rhombics are best for receiving and transmitting. W9UIZ who

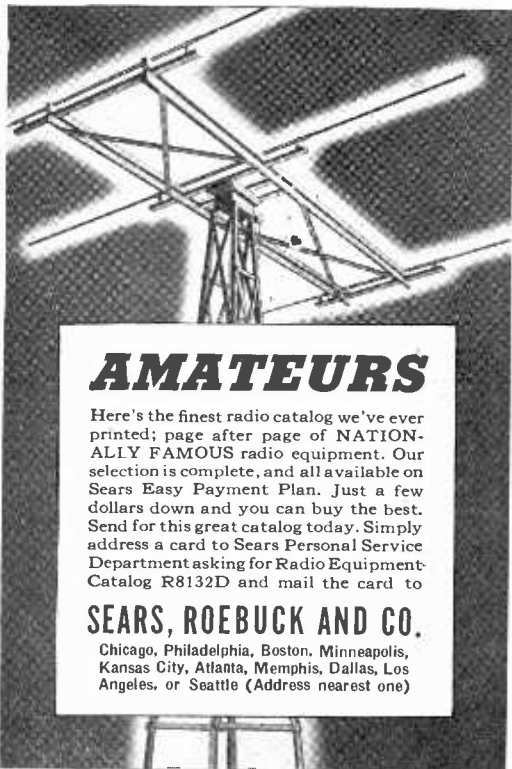

AMATEURS

Here's the finest radio catalog we've ever printed; page after page of **NATIONALLY FAMOUS** radio equipment. Our selection is complete, and all available on Sears Easy Payment Plan. Just a few dollars down and you can buy the best. Send for this great catalog today. Simply address a card to Sears Personal Service Department asking for Radio Equipment Catalog R8132D and mail the card to

SEARS, ROEBUCK AND CO.

Chicago, Philadelphia, Boston, Minneapolis, Kansas City, Atlanta, Memphis, Dallas, Los Angeles, or Seattle (Address nearest one)

FRANK LESTER'S

calling all hams to come & get it!

5-10 METER CONVERTER

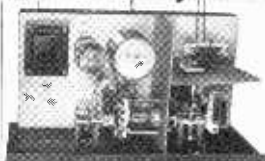

Tested, and now completely wired because you asked for it. Put new life in your 5-10 meter reception with the Converter that started all hamdom humming. The

LES-TET is a complete unit with 5 meter coils, output frequency 5.7 mc., and tubes. Write today for big **FREE** 1940 catalog that has everything in radio.

Completely wired
\$33.95
Includes tubes

New FREE Radio Catalog

Be sure to ask for it. A real money-saver. Do your shopping at home and save time.

New FREE Gift Catalog

Filled with ideas and values for Christmas. Get both catalogs when you send coupon.

LAFAYETTE HAM EQUIPMENT

Radio Wice Television Inc. formerly WHOLESALE RADIO SERVICE, INC.

Dept. 6M9-100 Sixth Ave., New York, N. Y.

Rush **FREE** 1940 Radio Catalog No. 78

Rush **FREE** Xmas Catalog No. 79

Name.....

Address.....

City..... State.....

PASTE COUPON ON PENNY POSTCARD



is a long one-hop away, comes in best on the rhombics. As mentioned before, some irregularities in such observations may result from comparison with a very high antenna which presents a null at some vertical angle at which signals may arrive.

Miscellany

It has been pointed out by C. B. Feldman that the year of maximum ionospheric disturbance and aurora may be 1940, the last having been 1930. This is not the same cycle, quite, as the sunspot cycle—or is another phase of it. It is important to us because it may bring about a lot of 200 to 400 mile "aurora skip" on five meters and possibly on 2½. Already, dx of this sort on five has been mentioned in these columns, and a considerable amount of it this fall on ten meters has been reported to us.

Perry Ferrell, Jr., in Linwood, New Jersey, says that he has improved his super-regen by adjusting the grid resistance value. It has been known that adjustment of the amplitude and frequency of the interruption oscillator, and other variables, can improve the super-regen quite a little. He now hears W1XPW on Meriden Mountain, Conn., 165 miles away, and W1XOJ in Paxton, Mass., at 255 miles. Both are around 43 Mc.

W1LLL in Hartford puts 65 watts in a pair of 6L6's in the final, feeding a vertical Q antenna. This rig has given him six districts and seventeen states this year.

W8OKC in Shamokin, Penna., has signed off for the season but plans to get ready for next summer by April so as not to miss out on anything.

W3AIR still prefers his acorn superhet to manufactured jobs although its i.f. channel is not as sharp. The transmitter final, a pair of 100TH's, takes up to 800 watts input, driven by the 808 job described in RADIO a few months back. A parallel rod tank circuit is used in the final to obtain the efficiency necessary to handle the input. Frank still uses the "good old lazy H," four horizontal half waves connected by crossed feeders and stub fed at the middle of the lower doublets.

HER has listened considerably this past summer for G's to break through. He has maintained schedules with G6YL on weekends.

G6YL sent us a correction to the time reported for reception of W8LRL in Germany. We quote the card as M.E.Z. 18.47 which is Central European time, equivalent to 1747 G.m.t.

Pictures

We can use in this column each month a few clear glossy prints of something of interest to the gang. Use a large negative for extreme clarity, if possible. Send us comments

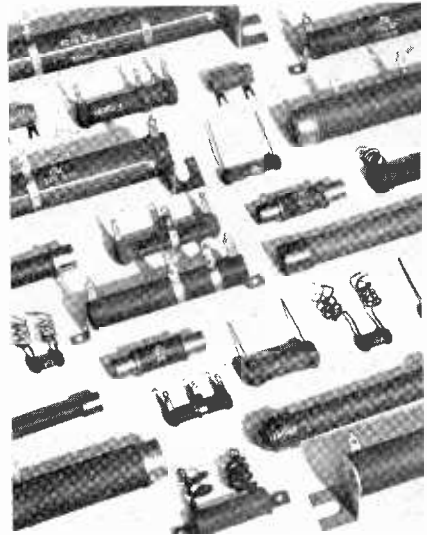

B and B

WE MAKE more different types of resistance units than any other company in the world—each having characteristics making it particularly suitable for a certain class of service.

There is naturally a temptation to devote this page to some new development in resistors or circuit application, but we should not neglect one of our old standbys—in fact, our Bread and Butter in the average ham shack—the cement-coated power wire wound resistors.

Their acceptance is no accident. In food mixers and Pullman cars, desk fans and submarines, furnace controls and dental equipment, in Peace and in War, they carry on their unspectacular task. They make no headlines but many headlines would not be made without them.

All the ingenuity we can muster in their design, all the care we give to their manufacture is to the end that you can install them, depend on them—and forget them.

INTERNATIONAL RESISTANCE CO.

401 NORTH BROAD STREET
PHILADELPHIA, PA.

on experiments and developments. whatever the frequency.

112 Mc.

W1JFF says that the main advantage in having a 2 1/2-meter band is that it has relieved the bootlegger interest.

W1DEI wonders about 2 1/2-meter dx reports and would like to see a list of verified reports. He feels that low atmosphere bending should be as favorable as on five meters, yet he has heard of no recent Boston contact with Connecticut or New York. What say, gang?

W9ARN comes forward with a suggestion that has considerable merit. In addition to a monthly honor roll on 56 Mc., he suggests a mileage honor roll for 112 and 224 Mc. We'll be glad to give it the space if you fellows will send in the dope.

56 Mc. Addenda

The old band just won't be closed up for the winter. On October 13, W6QLZ reports that it was open from 6:55 to 9:00 p.m. Mountain time but he could not contact anyone. He heard W6QQD in Salt Lake, a ten-meter harmonic. He was reported by W7GBI. He picked up a harmonic from Bolinas, California, and made out several weak stations

calling him. He was using a new six section vertical antenna at the time.

W4FPC in St. Petersburg, Florida, says that he used to be W8OJJ. He says that the band was open on October 7 from 6:48 to 7:55 p.m. Eastern time during which he contacted W3HYX W1CGY W2HWX W1IJ W9VHG ARN RGH ZHB and heard W9ZJB who also heard him. He had decided to go down from ten meters after hearing several W3's in Virginia coming through and, sure enough, five opened up. He was plenty busy, what with one station after another calling him. His transmitter starts with 6J5G ten meter crystal, doubles in a T-21, ending in a pair of 801's with plate rods, 90 watts input, feeding a matched half wave vertical. The receiver was an 1853 r.f. and 6K8G converter ahead of his regular receiver, but he used his ten meter three element beam for receiving. Signals were very similar to those on ten meters.

Meet Your DX in Person

[Continued from Page 50]

yond G2UJ in the London area, in a few minutes of tuning over the several code signals on the band.

A Hamfest

At Humphrey Swain's house we operated G2HG, working G8DN and W3ARN. The latter, who had called "CQ dx," had a loud signal with no fading but dropped out completely as do other W's at times. This may not be fading at all but simply the result of the W losing the G in QRM. He was called by OH2NQ soon after we lost him. Other stations heard were CT1JS, UE3LT, G2MI, G6WY, G2MZ, SM6VX, U3CY (calling KB6ILT), ST6KR, HA5X, VE2MU. There was echo on a Swedish station. Here again we heard only one W. Forty meters was filled with local phone heterodynes which effectively ruined the band for dx. The few

Everything For Your ROTARY BEAM

For 10 METERS \$22.50

Kit No. RB-2418 containing two Double End Telescoping Corulite Elements; Wood Frame Kit No. 2-W, and Hand-operated Rotomount No. BM-10—all for \$22.50.

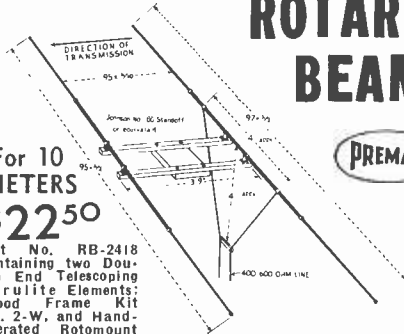

READ WHAT A BRIDGEPORT HAM SAYS:

"Since installing your Premax Beam I have worked some real DX and heard more Asiatics than ever before on any antenna I ever had. I just wanted to tell you how pleased I am, and to tell you: 'You've Got Something There!'"

Premax Equipment includes all types of rotary beams, vertical radiators, wood towers, rotomounts—all fully described in Radio Bulletin II-3 which you can obtain FREE at your radio jobber's.

PREMAX PRODUCTS

Div. Chisholm-Ryder Co., Inc.

4032 HIGHLAND AVE., NIAGARA FALLS, N. Y.

NEW TURNER DYNAMIC

Model 33D with Removable Cable Set, Full Tilting Head

Style and performance at low cost! Balanced line cable eliminates noise pick-up. Ideal for Ham, Recording, or P. A. work. Level -54 DB; Range 40-9000 cycles. Trouble-free operation. Available in all impedances.

\$23.50 List with 7 Ft. Cable set

Free Wiring Diagrams The TURNER CO. 901 17th St., N.E. CEDAR RAPIDS, IOWA



WRITE FOR FREE PARTICULARS

G phones fill the 300 kc. band thoroughly enough to demonstrate the crowding that results even when frequency allotments for phone use are substantially increased.

G2NK, G2GB, G2LW, G2ZQ, G6WY and G8DN arrived, some with their wives. One of the wives had been riding around on a fire truck to learn how to drive it during air raids if the firemen go to war. About the time that the room warmed up almost to a comfortable temperature, the women excused themselves on the grounds that it was getting stuffy!

H.A.M. Whyte, G6WY, started a dx Century Club hamfest with John Hunter, G2ZQ, while the other G2's discussed five meters. G2HG put on his gas mask to demonstrate how the Britisher carries on in the face of adversity. Because we had neglected to bring a bag of flashlight bulbs, not having pictures in mind when we started out, one of the gang gathered up some photoflood bulbs. These were arranged with a series parallel switch to permit adjusting the lights without using up their two-hour life.

We missed seeing G6FO who between issues of the *Short Wave Magazine* goes back across England to his home at Newport. Kenneth Jowers, G5ZJ, who is editor of *Television and Short-Wave World*, wanted to arrange a luncheon with G6DT, G2IS and W1KKP who was also in London, but non-delivery of messages spiked that. Among other invitations was one from G5ZT and



PA4BB and W9SLG with the Amsterdam canal in the background.

"Split-Hairs"

To CARDWELL, "splitting hairs" over the extent of accuracy in mechanical and electrical characteristics is like taking castor oil . . . unpleasant but absolutely necessary.

Recognized as a standard of comparison, CARDWELL components must never fail to justify their acceptance and selection by designers of fine commercial and amateur equipment.

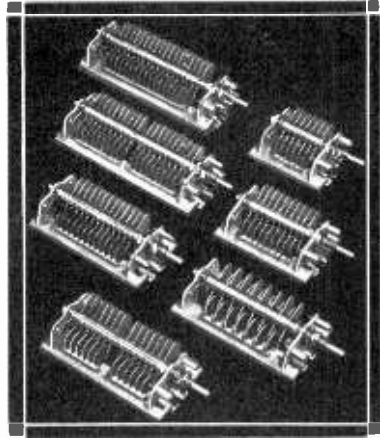

Specifications of "N" TYPE U.H.F. SERIES

FRAME—No frame or tie rods. Aluminum end plates supported directly on heavy lateral ceramic bars which carry stators.

SHAFT— $\frac{1}{4}$ " cadmium plated steel on which rotor assembly is securely locked.

PLATES—Aluminum alloy .040" thick with edges rounded.

BEARINGS—Long, nickel-plated brass, shoulder type front bearing, with ball thrust rear bearing. Laminated phosphor bronze rotor contactor.

AIRGAP—.070"—3000 V. peak—(NT)

.084"—4200 V. peak—(NP)

.171"—6000 V. peak—(NG)

MOUNTING—Single hole, front panel with mounting posts or chassis mounting on feet which form part of end plate. Or use type "M" bracket and mount upside down for lowest capacity to ground.

★ ULTRA-HIGH FREQUENCY SINGLES

Type	Max. Cap.	Min. Cap.	Nr. Plates	Air-gap	*Dim. "A"	Net Price
NP-50-DS	50	9	13	.084"	2-1/4"	\$2.10
NP-75-DS	75	11.0	19	.084"	3-1/16"	2.46
NP-100-DS	100	13	25	.084"	4-1/8"	2.82
NP-150-DS	150	19	39	.084"	5-5/8"	3.66
NG-35-DS	35	11	15	.171"	4-1/8"	3.12

★ ULTRA-HIGH FREQUENCY DUALS

Type	PER SECTION			Air-gap	*Dim. "A"	Net Price
	Max. Cap.	Min. Cap.	Nr. Plates			
NT-50-GD†	50	7	11	.070"	3-1/16"	\$3.60
NP-35-ND‡	35	5	9	.084"	3-1/16"	3.60
NP-35-DD	35	5	9	.084"	3-1/16"	3.21
NP-50-DD	50	9	13	.084"	4-1/8"	3.60
NP-75-DD	75	11	19	.084"	5-5/8"	4.32

* Dimension "A" is distance between inside faces of end plates. For overall length back of panel, add 1-3/32" to "A" dimension.

† .040" plates, buffed and polished

‡ .025" plates, buffed and polished

**THE ALLEN D. CARDWELL
MANUFACTURING CORPORATION**
85 PROSPECT STREET, BROOKLYN, NEW YORK

another from G8UN to meet the Manchester 100-watters, including G8TD and G6TL. G5ZT wanted to arrange five-meter schedules with W's, starting on 14 or 28 megacycles and working up if conditions are favorable; the war probably has changed all that, however, as our correspondence from Europe has dropped to zero.

Tea With G2YL and VU2AU

Nelly Corry, G2YL, asked us to come down to her beautiful home in Surrey. She has a very nice tennis court and several acres of formal gardens. She uses a single wire (mostly on ten meters) rather than to put up an unsightly beam. She drove us around in a ten horse power car that could make the hills without shifting—something that the smaller cars of other G's did not do so well. The roads are up, down, and around—a straight one is termed "uninteresting."

In the afternoon we again saw the television program. This time it was a half hour play and a repeat performance of a newsreel. Even at this distance from London it was satisfactory although two or three times 2YL adjusted the intensity control.

VU2AU arrived for tea. He had been on leave in England, operating G4BL. In India he had shifted to 20 in 1934, then to ten

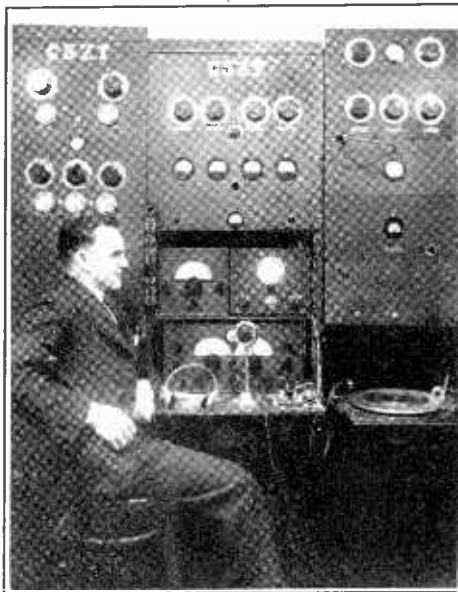

The equipment installation at G5ZT, Lancs., England.

meters two years ago, leaving only VU2AN on 40.

South to Sussex

G2ZV and 2DDD took us on to their homes in Sussex on the south coast. They operate electrical contracting and retail appliance businesses although washing machines are unheard of and ice boxes are just beginning to be sold, only some five percent of the people having them. Most of the English buy food in small quantities—a quarter pound of butter at a time—consuming what is on hand and otherwise relying on the refrigerators of the tradesmen. It is easy to see that they could not go a week or perhaps not more than a day without shopping. Both are very active on five meters, having jointly won the Mitchell-Milling trophy presented by the R.S.G.B. for the best performance in 56-megacycle field day work, backed up by experimental work on the band during the previous year. In fact, G2ZV and G6CW hold the 56-Mc. record, a 155-mile contact. At his house we heard G5TX on the Isle of Wight and another G on the far side of London, both on code. We discussed five-meter problems by the hour, convincing them that they should build up a concentric-line-tuned acorn superhet as the only possible improvement on their well constructed equipment. G2ZV has a horizontal closely spaced four element beam on which he is able to pull in London television at a distance of some 80 miles. The broadcast this time included an indoor tennis match in which the

*I guarantee you
the fairest and
squarest deal . .*

It will pay you to write to me whenever you need any Amateur Equipment!

I will give you the latest and best apparatus. I will give you the lowest prices obtainable—anywhere! I will give you the fastest service. I will give you the most liberal trade-in allowances. I will give you easy time payment terms at only 6% cost. I will give you ten day trial of any receivers. I will give you my personal attention and full cooperation.

In short, I give you every possible reason for dealing with me—and continuing to deal with me!

For complete and lasting satisfaction—be sure to write to me.

73.

Bill Harrison, W2AVA

HARRISON RADIO CO.
9 WEST BROADWAY, NEW YORK CITY

.

Authorized Factory Distributor of **ALL**
AMATEUR RECEIVERS, TRANSMITTERS,
KITS, TUBES, PARTS, AND EQUIPMENT

Since 1925 — "Harrison has it!"

ball could be followed. In driving around the countryside, on roads that were sometimes worn ten feet below the adjacent fields, we visited the ruins of a Roman villa built in 146 A.D. It had been provided with central heating and running hot water—but the idea seems not to have caught on well in England these past 1793 years, judging from the fact that we could see our breaths in many homes. One quaint "pub" we passed displayed a sign that Charles II stopped there for a beer after his battle with Cromwell.

Passing through Portsmouth, the south coast naval base, we picked up G2XC who is an authority on sunspots, magnetic activity and ionosphere conditions. In this work he makes his own sunspot observations, using a lens system to project a four inch image of the sun on a screen. He has covered the world on ten meters with 30 watts input, and also operates on five.

The whole gang came aboard the *Kungsholm* at Southampton for a dinner. They seemed to enjoy it well, except that none would eat an olive.

G8LY in Winchester

The next day we met Constance Hall, G8LY, in Winchester. She took us through a school older than Eton, where the boys eat from flat slabs instead of plates, keeping



W9SLG and DE0853 on Unter Den Linden in Berlin.

★★★★ **FLASH** ★★★★★
RADIO SUPPLY'S
"MOBILE MILEAGE"
CONTEST

NEW — DIFFERENT — EXCITING !! — "LET'S GO!"

RULES:

1. Equipment used shall be operated entirely from battery of mobile unit or generator mounted thereon.
2. Power input to final stage shall not be in excess of fifty (50) watts.
3. Equipment may be of any make, composite or commercial.
4. The word "mobile" shall include automobiles, airplanes and boats.
5. No antenna other than those mounted on the mobile unit may be used.
6. Contacts whi'e mobile unit is not in motion will be acceptable.
7. Each station worked shall count but once in the total score.
8. Total score will be derived by computing the airline distance from the mobile unit to the station contacted and adding this to the total.
9. Scores submitted shall include: a. Type of equipment, b. Call letters of contacted stations, date of contact, location of mobile unit and reports received.

FIRST PRIZE: Howard 430 Receiver
 Many other prizes. Contest starts January 1st, 1940. Ends February 28th, 1940. Two full months to run up a "Mobile Mileage" score.

Get started today!
 Scores must be mailed by March 9th, 1940.

BE PREPARED

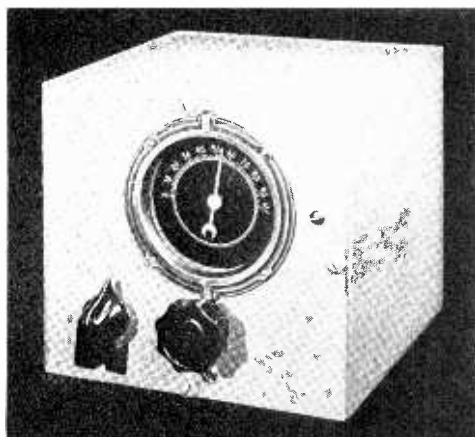

XCI Kit	\$ 9.95
6K8 Tube90
Complete	\$10.85
Wired and tested (labor)	4.00
Total Cost, ready to operate	\$14.85

RADIO SUPPLY CO.

950 S. Broadway TR-0383 Los Angeles, Calif.



**Buy a Fresh
Copy Today
of the
RADIO
AMATEUR
CALL BOOK**

The CALLBOOK is the only publication that lists all licensed radio amateurs in the United States and over a hundred and seventy-five different foreign countries.

Each issue also contains a world map showing amateur prefixes, press, time and weather schedules, amateur prefixes listed alphabetically and by countries and a world time conversion chart.

Complete . . . Accurate . . . Up-to-Date

Issued Quarterly

MARCH . . . JUNE . . . SEPTEMBER and DECEMBER

Annual subscription \$4.00

Single copies \$1.25

*Buy your copy now from your radio jobber
or direct from:*

RADIO AMATEUR CALL BOOK, Inc.
608 S. Dearborn St. Chicago, Ill., U. S. A.

THE "RADIO" NOISE REDUCTION HANDBOOK

Another "only book of its kind" by the Editors of "Radio." Tells in simple language how to eliminate or greatly reduce practically every form of radio noise with the exception of natural static.

Use of the noise-reducing systems described in this book will frequently mean the difference between an unintelligible signal and one which can be read with ease. Particular emphasis is laid on the elimination of the noise at its source.

35c U.S.A. (including possessions) Elsewhere **40c**

THE EDITORS OF **RADIO** 1300 Kenwood Road, Santa Barbara
CALIFORNIA

gravy aboard by making a wall of mashed potatoes. Dessert was served on the reverse side of the slab. This was a "public" school in which few of the public enter by high scholarship but most have to pay the full fare, after being enrolled at birth. Getting an education in England is not the same as here! Another interesting spot is a building in which the Saxon kings of England were crowned (before 1066), in which hangs a 30-foot table top reputed to be that of King Arthur and his Knights of the Round Table—if there was a King Arthur. At least the table deserves note for its age because it is documented back seven hundred years at which time it was considered ancient and was hanging where it is now.

G8LY is located at North Waltham Rectory, outside of Winchester, where she must operate from battery power. She dismantled a seven horse power Austin car to make a gasoline driven generator for charging her batteries. She is active on five meters but has not had the excellent dx success of G2ZV and 2DDD. Last summer, she was given the job of preparing 56 Mc. notes monthly for the *T & R Bulletin*, so with G2YL doing 28 Mc., the u.h.f. section is exclusively in the hands of the YL's. A letter from G6CL dated late in August, however, hinted that upon declaration of war, the *Bulletin* would probably cease publication—and we have received no copy of the September issue.

Finis

There is no doubt at all that our week in England was the high spot of the trip. We were able on numerous occasions to hear the English viewpoint as discussed—or argued—between Englishmen, such as whether one should remove his coat in very hot weather or keep it on to maintain the dignity of the middle class. The people everywhere were not only courteous but would see something humorous in nearly everything. We had expected them to be more reserved than they were. The English may have made some fun of our "American" in the past, but they use as much slang as we, and with the help of our movies, their language may become very much like ours. There is little doubt but that the average American is constituted more like the English than any other European people.

So after a very busy five weeks, we returned to New York where, for the first time, customs men asked us to unlock our bags for inspection. We feel that we have a better appreciation of the conditions under which dx amateurs work, and we hope that you, taking an "armchair cruise" with us, have enjoyed it too.

four columns with an average of 90 calls per column, and if your totals are high enough to place above the lowest in the column, your call and totals will appear in the earliest issue possible. However, if you do not have enough to get into the Honor Roll, don't hold out, because your dx is important news for the department and your totals are filed. Thereafter it is only necessary to send in your additions to the zones and countries, and when you have enough to qualify it will automatically be inserted in the list.

Just a word of caution about some of these "fony" calls. If you have a reasonable doubt about a station, and you send it in for counting, I would not feel too badly if we leave it out. In most cases we try to notify you of this discovery, but cannot always guarantee it. Then too, fellows, when you send in additions to your totals, please list the revised figures as this will help us considerably in locating your previous total. We maintain a file of over 600 calls which are in numerical order of zones worked, and it is quite a job sometimes to locate your card when you just write in and say "I've added two more zones by working so-and-so, and so-and-so, please add these to my Honor Roll total." It is better to include, "This gives me 34 and 105," and we will know you previously had 32 zones.

W2GVX has been spending his summers up at Lucerne, Maine, operating portable. He has worked a flock of stuff with rig which uses a 150T with 700 watts input. W2ZA waited a long time but he has a mighty fine list of dx worked for the Honor Roll. Yessir, 39 zones and 134 countries. Oh yes, of course, he just worked AC4JS to get Zone 23. Think nothing of it as it must be getting monotonous on the east coast by now. Durn it, why wasn't my call W2QD or something. I guess I just don't do something right. W2ZA has done very well in the Marathon, too, with 37 zones and 97 countries. Here's W2GRG with a bunch of new ones . . . hey, you can't do this to us. Yes, another AC4JS QSO, and isn't this parade just wonderful? You know, I was just wondering if by chance AC4JS hadn't as yet reached Zone 23, or Tibet. We all know he was headed for Tibet, but maybe . . .? That is a heck of a thing to bring up at this time, isn't it? Sez all of you, "He'd better be in 23." Yeah I agree with you he'd better be there, and I think he is. I started to tell you about W2GRG . . . well, he has hooked VU7BR, HB1CE, VU2CQ, making a total of 38 and 127.

SU1WM says that VQ8AT 14350 T9 is in the Chagos Islands. Bill has his Marathon up to 36 and 107. W8OSL is another of the members of the Zone 23 Club. Along with AC4JS Jule has taken in VQ5WES 14040 T6, KH6KKR, KH6DTR. W3CDG is back on again and worked U2NE, J2KN, ZS6EW, PK1TM, KA1FG, and KB6RSJ. W8GBF says that a friend of his, George Meek, W8IB is on in Macau signing CR9AU. He uses 25 watts into an 807 on the high end of 20. W9GKS adds KB6RSJ for his 89th country. W1AB says that AC4JS must be old stuff to me by now, but he worked him anyway. Horace also got VU7BR and MX1A.

SUN SPOT

FOR "RADIO" READERS FILAMENT TRANSFORMERS

Bracket Mounting—Standard Construction
—Fully Guaranteed.

2½ Volts 10 Amps **70c**
10,000 Volts Insulation
6.3 Volts 6 Amps **85c**
2500 Volts Insulation

These transformers bear the same warranty as when formerly sold at full price.

U. T. C. CATHODE MODULATION TRANSFORMERS

Type	Audio Power	Mod. RF	Net Price
CM-15	15 Watts	200 Watts	\$2.35
CM-16	35 Watts	500 Watts	3.23
CM-17	100 Watts	1000 Watts	7.06

This new, amazingly simple and inexpensive method of modulation makes possible modulation of Class C inputs with only 10% of audio power. 300 Watts of Class C can be modulated with only 30 Watts of audio modulator output.

THE LATEST IN RADIO AT SUN'S HAM SHACK

New Hammarlund Super-Pro—National NHU—Hallcrafters SX24—National—Hallcrafters—Hammarlund—RME—RCA—Howard. Come to SUN and see and operate these receivers yourself.

SUN'S TECHNICAL SERVICE

Sun Radio is manned by experienced Amateurs and technical men. We are here to serve you in every way possible. You will find us pleased to assist you with your problems on transmitters, receivers, antennas or special equipment.

- ★ EXPORT ORDERS SOLICITED
- ★ MAIL ORDERS PROMPTLY FILLED

RADIO CO.

212 Fulton Street, New York, N. Y.

Cable Address: SUNRADIO NEW YORK

Dept. WR

NEW W.A.Z. MAP

The "DX" map by the Editors of "Radio" consists of the W.A.Z. (worked all zones) map which shows in detail the forty DX zones of the world under the W.A.Z. plan. This has become by far the most popular plan in use today for measurement of amateur radio DX achievement.

An additional feature of this new, up-to-date edition is the inclusion of six great-circle maps which enable anyone, without calculations, to determine directly the great-circle direction and distance to any point in the world from the base city for the map in use!

35c

POSTPAID ANYWHERE
(Seven international reply coupons accepted as 35c)

THE EDITORS OF **RADIO** 1300 Kenwood Road, Santa Barbara
CALIFORNIA

W2GVZ feels several years younger since working Zone 23. Pat now has 39 zones and 132 countries. He recently installed a new 3-element beam for 20 and 10 but with conditions poor for him, he says he thinks he will let the neighborhood birds occupy it. W3TR is hoping he will get a card from either LX1PP or LX1SS. W6NLZ hooked up with U9ML, U9AW and YU7XU making a total of 36 and 103. W3KT nailed a couple of new countries in VU7BR and HB1CE. Totals now 37 and 103. W6QL says U8BC is in Tomsk, which is Zone 18. Also XU6UK gives his QRA as Box 164, Kukong, Kwangtung Province, Chica. His frequency 14387.

W4DMB has a few that look good—TG9BA, CT3AB, ZD4AB, VP6MY, VP9X, K4AAN, VP2AC, PJ5EF, CR4MM. This gives Dub 37

and 108. W3AYS says the WPA are going to clear the lot where he was going to put one of his poles . . . so what to do. Well, he immediately went on phone. I don't see any connection, but it could be made into a gag. W4FVR grabbed off TG9BA for his 130th country, zone 38. W8BTI is sailing right along with his miscellaneous activities. Carl is on phone a great deal now and has 27 ad 63 in the Marathon while c.w. and phone are 37 and 113. For the Honor Roll 8BTI has done himself some good by boosting to 39 and 154. W9ELX adds a few U9BC, ES5D, XU5WT, XU8MI, J8CH, and these help make 38 and 109.

W2GT, who also is a member of the Zone 23 Club now has 39 zones and 144 countries. W3FEW just worked K7GOR for his 33rd zone and 83rd country. W3GGE who happens to be the cousin of W3FEW, found a new zone while home from school this summer. It was VU7BR, which makes Hugh's total 36 and 106. Hugh lists the QRA of CP4ANE 14330 T9, as Ray Hoover, Lloyds Aero Boliviana, Cochabamba, Bolivia. QRA of HClAR 14300 T6, is Alfredo Momoero, Tena Oriente, Ecuador.

Correction . . . XU8MI Not In Egypt

In the October issue we made mention of XU8MI going to Cairo. This was in error as it should have been XU8DI that was going to Egypt. We received word from W6KFY that ZL1MP is now an aerial gunner in the New Zealand Squadron and is stationed in London, England. He says that most of the op's have been made aerial gunners.

We are very glad to hear from Jack Clarricoats, G6CL. He informs us that the R.S.G.B. is carrying on from his private address, 16 Ashridge Gardens, London, N. 13. All correspondence may be sent through to him directly. Art Milne, G2MI, who writes the dx column in their *T & R Bulletin*, under the heading of "The Month On The Air" will continue to run the column. However, as Jack says, maybe it should be called, "The Month Off The Air." Anyway, the R.S.G.B. QSL Bureau will function from, 29 Kechill Gardens, Hayes, Bromley, Kent, which is the private address of G2MI. The *T & R Bulletin* is very anxious to receive dx news from all parts of the world for their column. It really is wonderful to know they are continuing their interest although unable to get on the air. To all of you dx men, anywhere in this world of ours, if you will drop a few dx notes to Art Milne at the above address, they will be grateful.

From Jack we also learn that H.A.M. Whyte, G6WY and John Hunter, G2ZQ, are both officers in the R.A.F. as are Ken Jowers, the short wave Editor of *Television and Short Wave World*, and Austin Forsyth, Editor of *Short Wave Magazine*. G6CL finally raised Nevada before things broke loose over there, and now that's the 48th for him. Jack also snagged a K6 and VR4AD to make his final standing 38 zones and 112 countries. Another item which he brings up is that it's pretty tough to listen to the W6 and W7 gang pour through 599 on 28 Mc. and not be able to give them a shout. Ham radio in England has been closed down since the night of August 31st. On August 30th the log of W6QD shows G5YU,

THE EDITORS OF RADIO 1300 Kenwood Road, Santa Barbara CALIFORNIA

Kindly send me the items listed below for which I enclose \$ _____ in payment.

- "Radio" (one year)
- "Radio" (two years)
- "Radio" (three years)
- "Radio" Handbook (standard edition)
- "Radio" Handbook (library edition)
- "Radio" Antenna Handbook
- "Radio" Telephony Handbook
- "Radio" Amateur Newcomer's Handbook
- "Radio" Noise Reduction Handbook
- Radio Technical Digest (one year)
- Radio Technical Digest (two years)
- Radio Binder
- Radio Technical Digest Binder
- New W. A. Z. Map

Name Call

Address

Note: All shipments are **prepaid** by us. Current editions are always supplied unless previous or future editions are requested in the original order.

GM6RV and G8LT as worked. There is nothing particularly remarkable about this, but the guy who worked them from QD was G6HB, who happened to be in town for a few hours. As luck would have all three stations were his own pals. G6HB is an op on one of the British boats.

W1BUX was really "boined" up when he saw he only had 132 countries according to the text of the October column. This was wrong and we'll never know who made the vital error, but now Doug has 152 countries worked and 38 zones. Just so something won't slip this time and Doug will get all of the countries in, I'll repeat that W1BUX now has 152 countries.

G2MI sends in his list of 37 zones and 110 countries, and says that life is pretty empty with no ham radio and television. W2IOP is going to rebuild his rig and then really settle down for some plain and fancy operating. Larry says there is only one thing that will not be changed and that is Priscilla. Guess she's there to stay. W1EFM hooked up a little portable rig using an 807 and strung up a 33-foot antenna, and after a six weeks effort he ended up with 15 zones and 34 countries. Some of the better ones are CR7BN, PJ3LR, YU7LX, YR5EF, HB1CE, SV1RX, FA3RY, CT3AB and ZS. I would say that was ok for QRP. W9VDX has now 35 zones and 80 countries, his latest being U9BC and U9ML.

AMATEURS . . . DON'T PASS UP THIS AMAZING OFFER

YOU NEED THIS BOOK!

Do you want to enjoy radio and television more completely? . . . to get more pleasure out of building your amplifiers, television receivers, transmitters, gadgets, etc.? Then let this great RADIO NEWS Data Book guide you through your radio and television problems!

Gathered between the covers of this authoritative Data Book are sections on television, receivers, transmitters, instruments, amplifiers, gadgets, in fact, practically everything you want to know about radio and television is covered. Each section, easy-to-read and easy-to-understand, is profusely illustrated with charts, diagrams and hook ups. Amateurs, here's a wealth of radio and television information that you can't afford to pass up.

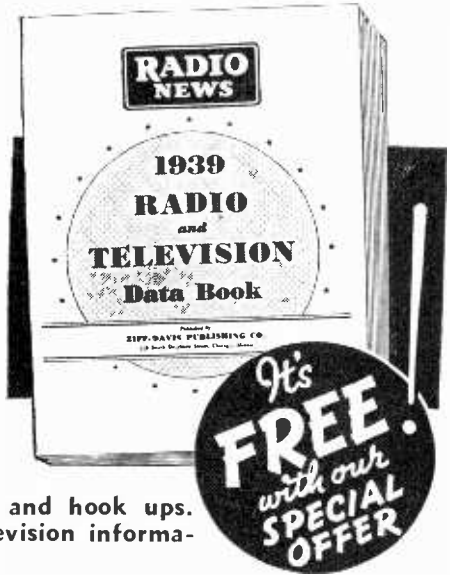

SEND FOR YOUR FREE COPY NOW

YOU can obtain this great RADIO NEWS Data Book on Radio and Television absolutely *free of charge!* Just fill out and return the coupon to the right with your remittance of \$1.00 for 12 issues of RADIO NEWS, and we will rush a copy to you without charge. **ACT NOW!** Our supply of these valuable books is limited!

**RADIO NEWS, Dept, R1
608 S. Dearborn St., Chicago, Ill.**

Enclosed find \$1. Send me the next twelve issues of RADIO NEWS and rush a copy of the 1939 RADIO DATA BOOK to me *without charge!*

Name

Address

City & State

*(Foreign postage, except Canada,
\$1.00 additional per year)*

Advertising Index

Aerovox Corporation	74
Allied Radio Corporation	76
American Microphone Co., Inc.	74
Bliley Electric Company	81
Bud Radio, Inc.	85
Burgess Battery Company	66A
Burstein-Applebee Company	84
Cardwell Manufacturing Co., The Allen D.	89
Centralab	79
Cornell-Dubilier Electric Corp.	8
Eitel-McCullough, Inc.	71
Hallicrafters, Inc., The	65
Harrison Radio Company	90
Henry Radio Shop	73
International Resistance Co.	87
Kenyon Transformer Co., Inc.	83
Lindberg Mfg. Company	82
Mallory & Co., P. R.	75
McGraw-Hill Book Co., Inc.	76
Montgomery Ward	78
Ohmite Manufacturing Co.	82
Premax Products	88
Radio Amateur Call Book	92
RCA Manufacturing Co., Inc.	Cover IV
RADIO <i>Amateur Newcomer's Handbook</i>	84
RADIO <i>Antenna Handbook</i>	80
RADIO Binder	77
RADIO for Christmas	Cover III
RADIO <i>HANDBOOK</i>	Cover II, 3
RADIO <i>Noise Reduction Handbook</i>	92
RADIO Publications	94
RADIO <i>WAZ Map</i>	93
Radio Supply Co.	91
Radio Wire Television, Inc.	86
Sears, Roebuck & Co.	86
Signal Electric Mfg. Company	82
Solar Manufacturing Corporation	78
Standard Transformer Corporation	69
Sun Radio Company	93
Taylor Tubes, Inc.	7
Thordarson Electric Mfg. Co.	5
Turner Co., The	88
Ziff-Davis Publishing Co.	95

RADIO

In the October issue it was noted that W8BTI was supposed to have worked "22 zones and 4 countries" on phone. Obviously there is something wrong, and inasmuch as the printer is a long way from here, we'll say he just dropped off a "4" from Carl's total. It should have been 44. In the same issue we showed a photo of a group of South African hams. In the caption for description it listed all the ZS calls and then went on to say "some of the gang of Division Six Of South America." Isn't that just great having ZS's in South America?

Fred Albertson, W3FMC, is President of the Washington Radio Club, and on January 13, 1940 they are planning a demonstration of Major Edwin H. Armstrong's new system of frequency modulation. This will be the first public demonstration outside of New York, and Major Armstrong will be there personally. Two Radio Engineers, Jansky and Bailey will actually stage the affair, and they hold a permit from the FCC to use this system of frequency modulation for a high frequency broadcast on 43.2 megacycles. The call letters are W3XO.

Well, this just about ends it for this time. I would like to hear from all the fellows overseas, even though they are not on the air. We are all interested in what you are doing, and you might keep us informed as to your activities. All of you who participate in RADIO's contest, please don't delay sending in your log. Also we may be able to crowd a few unofficial scores into the January issue if they are sent in right after the conclusion of the second week-end, or December 4. Once again I have a good chance to plug 40 meters—don't overlook this band during the contest.

Past, Present and Prophetic

[Continued from Page 6]

Heresy

We were not a bit surprised when that iron-antenna-wire story in the November issue caused a lot of readers to throw up their hands in horror.

It all came about because the editor bought more iron guy wire and less copper antenna wire than he needed for the job at hand. When the copper wire ran out before the antenna was finished, he cast a speculative eye in the direction of the surplus guy wire. He tried to figure what reasons there might be for not using it, but couldn't think of any. As we go to press he is still loudly lamenting the fact that he spent perfectly good \$\$\$ for copper antenna wire when it could just as well have been galvanized iron.

There is no cause for alarm; the doctor says that it is unlikely he will become violent.

Hang on tight and watch out for flying tomatoes and rotten eggs while we take you zooming across the band in our new "One Sixty", built from the article on page 29.

The Marketplace

Classified Advertising

(a) Commercial rate 10c per word, cash with order; minimum, \$1.00. Capitals: 13c per word. For consecutive advertising, 15% discount for 3d, 4th, and 5th insertions; 25% thereafter. Break in continuity restores full rate. Copy may be changed as often as desired.

(b) Non-commercial rate: 5c per word, cash with order; minimum, 50c. Available only to licensed amateurs not trading for profit; our judgment as to character of advertisement must be accepted as final.

(c) Closing date (for classified forms only): 25th of month; e.g., forms for March issue, published in February, close January 25th.

(d) No display permitted except capitals.

(e) Used, reclaimed, defective, surplus, and like material must be so described.

(f) Ads not relating to radio or radiomen are acceptable but will be grouped separately.

(g) No commissions nor further discounts allowed. No proofs, free copies, nor reprints sent.

(h) Send all Marketplace ads direct to Santa Barbara accompanied by remittance in full payable to the order of Radio, Ltd.

PRACTICAL Radio and Communication Engineering Course for Home Study offered by Smith Practical Radio Institute, Department R129, 1311 Terminal Tower, Cleveland, Ohio. Information Booklet Free.

TRANSMITTING TUBES REPAIRED Save 60% Guaranteed work. **KNORR LABORATORIES**, 5344 Mission St., San Francisco, Cal.

QSL's—Samples, Brownie, W3CJI, 523 North Tenth Street, Allentown, Pennsylvania.

AC Generators and plants. Have some good buys in used machines. Ideal for emergency. **Katolight**, Mankato, Minnesota.

CRYSTALS Commercial-Amateur. Literature upon request. **Angelus 7310**. C-W Manufacturing Co., 1170 Esperanza, Los Angeles, California.

CRYSTALS in plug-in heat dissipating holders. Guaranteed good oscillators. 160M—80M \$1.25 (No Y Cuts) 40X \$1.65. 80M Vari-frequency (5 Kilocycle variance) complete \$2.95. State frequency desired. C.O.D.'s accepted. **Pacific Crystals**, 1042 South Hicks, Los Angeles, Calif.

QSL's—Quality Workmanship. Neatest designs! **Fritz**—455 Mason, Joliet, Illinois.

14" RACK with panels, chassis. \$4.25. **R. H. Lynch**, 970 Camulos, Los Angeles, Calif.

METERS, microphones, pickups, repaired—**W9GIN**, 2812 Indiana, Kansas City, Missouri.

QSL's—By **W8NOS**—"The QSL Craftsman"—13 Swan St., Buffalo, N. Y.

SPECIAL—New 3000 volt ct @ 250 ma \$6.00. 5000 volt ct @ 250 ma \$9.00. Supply limited! We rebuild defective Power and audio transformers. **PRECISION TRANSFORMER CO.**, Muskegon, Mich.

BUY direct for less! Postage prepaid. Write for list. **PRECISION TRANSFORMER COMPANY**, Muskegon, Michigan.

RECONDITIONED guaranteed receivers and transmitters. Practically all models cheap. Extra 25% discount on many models during December. All shipped on ten day free trial. Terms. List free. **W9ARA**, Butler, Missouri.

RADIO KITS—\$3.95 up. Complete. Single band; all-wave; 5-10 tubes. Save 50%. Radio and parts catalog—**FREE**. **McGee Radio**, P-2015, K. C., Mo.

CRYSTAL OVENS adaptable any round holder 2x1 inches or less. Specify 6.3 or 2.5 voltage. \$1.50 postpaid. **Sodaro Manufacturing**, 1115 North Lockwood, Chicago.

JOE KEESE, W9KEH announces purchase of one-third interest in **VAN SICKLE RADIO CO.**, 1113 Pine St., ST. LOUIS, MO. Anything in Radio, new or used.

"**GOES** over like a KW! Your call in gold-filled wire on chain tieclip. A WOW of a gift! One dollar prepaid. **W9SZB**."

NATIONAL SW-5. Bandspread, general coils. Power supply. Best offer. **W6NSX**.

WANTED: Old spark equip. transformers, quenched gaps, synchronous rectifiers, mica conds.; etc. Pse. state price first letter. **W-5KD**, 215 NW 19th St., Oklahoma City, Okla.

NEW type vestpocket exposure meter, use with any movie or still camera. 35c prepaid. **Photocraft**, Southport, Indiana.

SACRIFICE. Modern all-band KW Phone Station, as parts. Write **W9BTJ**, 306-1st Ave., South Moorhead, Minnesota.

SELL. NC 80x. \$65. NC 81X \$65. Both in fine condition. NC 81X 5 mo. old. **W6QFB**, 6207 West Fifth St., Los Angeles.

Changes of Address

To become effective with
The Next Issue
must be **RECEIVED** at **SANTA BARBARA**
by the **5th** of this month

Address labels are shipped to our mailers on that date. Remember: under U.S. postal laws, magazines sent to an old address are junked unless forwarding postage has been left in advance with the postmaster; unlike letters and cards, magazines are not forwarded either free or collect (except to addresses in the same city).

Circulation Department

Buyer's Guide

• Where to Buy It •

PARTS REQUIRED FOR BUILDING EQUIPMENT SHOWN IN THIS ISSUE

The parts listed are the components of the models built by the author or by "Radio's" Laboratory staff. Other parts of equal merit and equivalent electrical characteristics usually may be substituted without materially affecting the performance of the unit.

REED DUO-POWER MODULATOR

Page 19

All Tubular condensers—Aerovox 284, 484, 684
C₂—Mallory-Yaxley CS-131
C₅, C₇—Mallory-Yaxley TS-101
C₈—Mallory-Yaxley CS-133
C₁₀—Mallory-Yaxley HS-693
R₀, R₁₀, R₁₁, R₁₂, R₁₅—I.R.C. AB
T₁—Thordarson T-84D42
T₂—Thordarson T-11M77
T₃—Thordarson T-51D00
T₅—Thordarson T-19F98
CH—Thordarson T-57C53
PF, PL—Mallory-Yaxley 310-G
J₁, J₂, J₃—Mallory-Yaxley 701-A1
Special input jack—Yaxley 6 or 706 rebuilt
C battery—Burgess 5360

• • •

DAWLEY SERIES CATHODE MODULATION

Page 24

810 AMPLIFIER—FIGURE 3

C₁—Cardwell MR-100-BD
C₂, C₃—Cornell-Dubilier Type 4-12D2
C₄, C₅—Bud 1519
C₆—Cardwell XG-50-KD
L₁, L₂—Bud Plug-in Coils
PC—Ohmite parasitic suppressor
RFC—Hammarlund CH-500

• • •

FOUR-6L6 MODULATOR—FIGURE 6

All tubular condensers—Solar Sealdtite
C₂, C₆—Solar Dual—LG5-88
C₇—Solar M-408
C₄—Solar DT-874
C₅—Solar DT-881
All 1/2-watt res.—Centralab 710
All 1 watt res.—Centralab 714
10-watt resistors—Ohmite Brown Devil
Bias Cell—Mallory-Yaxley
T—Thordarson T-19F98
CH—Thordarson T-13C28
Chassis—Bud 1193
Tubes—RCA

• • •

"ONE-SIXTY" EXCITER

Page 29

C₂—Cardwell ZU-100-AS
C₃, C₆—Cornell Dubilier 5-W
C₄—Cornell Dubilier type SM

C₇—Cornell Dubilier BR-845 Beaver
C₇—Cornell Dubilier 1-W
RFC—Hammarlund CHX
R₂—Ohmite "Brown Devil"

• • •

"PIDGEE."

Page 36

C₁, C₂—Cardwell ZU-100-AS
C₃—Solar S-0219
C₄—Solar MW-1227
C₅, C₆—Solar MW-1223
C₇—Solar M-010
C₈, C₉, C₁₀—Solar M-408
R₁, R₂—Centralab 514
R₃—Centralab 516
R₄—Ohmite Brown Devil
T₁—Stancor A-4706
T₂—Stancor P-948
CH₁, CH₂—Stancor C-1002

• • •

HIGGY MODULATION INDICATOR

Page 60

C₁, C₃—Aerovox 1467 mica
C₂—Bud 902 condenser
C₄—Aerovox 484 tubular
R₁, R₂—I.R.C. BT-1/2
C.O.R.—Triplett C-4 rectifier
M—Triplett 321 milliammeter
Tube—RCA
Cabinet—Bud 1098

DON'T MISS IT!

"RADIO" for January

200 Pages!!

No extra cost to subscribers!
Price: 50c in U.S.A. and CANADA

subscribe now!

SEE OPPOSITE PAGE

"Radio" for Christmas

AN IDEAL GIFT

RADIO's annual Christmas gift rates will be in effect from November 15th to January 15th. To radio amateurs with a "fellow ham" to remember, to radio employees with a radio-minded employer who must not be forgotten, and to radio manufacturers and distributors who want to remind a favored customer repeatedly through the year of their appreciation of his business, a RADIO subscription is an ideal (and effortless) solution of that puzzling Christmas shopping problem.

ONE SUBSCRIPTION (one year)	\$2.50
TWO SUBSCRIPTIONS, each	2.35
THREE or more SUBSCRIPTIONS, each	2.25
SIX or more SUBSCRIPTIONS, each	2.00
TWELVE or more SUBSCRIPTIONS, each	1.75

Subscriptions at \$2.00 or less must be **cash with order.**

Above rates apply for U.S.A., Canada, Newfoundland, Cuba, and Mexico. To Pan-American countries and Spain, add 50c per subscription. Elsewhere, add \$1.00 per subscription.

YOU MAY ENTER OR RENEW YOUR OWN SUBSCRIPTION AT THESE RATES

Rates for more than one subscription, as listed above, apply only on gift orders entered and paid for at one time by one individual or company. Unless otherwise requested, the subscriptions will be commenced with the January issue, which will be delivered as near Christmas as possible, together with an attractive card announcing the gift and the sender's greetings; those who are at present subscribers will automatically have subscriptions extended unless otherwise requested.



240-WATT PHONE OUTPUT WITH

TWO \$3⁵⁰ TUBES!

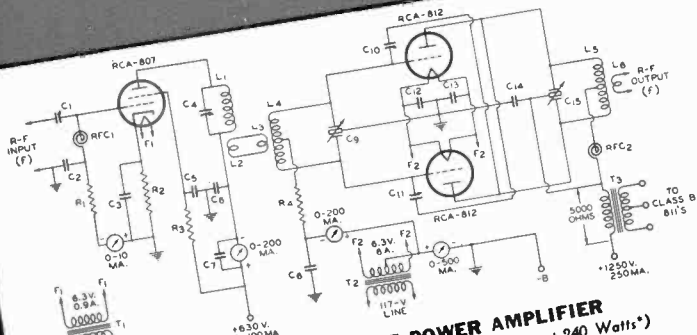

PLATE-MODULATED R-F POWER AMPLIFIER (Class C Telephony Power Output 240 Watts*)

With Beam Power Driver Stage (Class C)

- C₁ = 10-70 mfd. mica trimmer
- C₂ C₃ C₄ C₅ C₆ C₇ C₈ C₁₂ C₁₃ = 0.005 mfd. mica
- C₉ = 165 mfd., 0.05" air-gap
- C₁₀ C₁₁ = 4-7 mfd., 0.140" air-gap
- C₁₄ = 0.002 mfd., 5000 volts
- C₁₅ = 100 mfd./section, 0.07" air-gap #
- R₁ = 10000 ohms, 1 watt

* Approximate. # Adjust C₁₅ to about 1.2 mfd./plate potential. An insulated coupling shaft must be inserted between the rotor shaft of C₁₅ and its control dial.

- R₂ = 300 ohms, 5 watts
- R₃ = 4000 ohms, 10 watts
- R₄ = 2500 ohms, 10 watts
- RFC₁ RFC₂ = 2 1/2 mh. r.f. choke, small size
- L₁ L₄ L₅ = 2-turn coupling links
- L₂ L₃ L₆ = Filament transformer, 150 watts
- T₁ T₂ = Modulation transformer, 150 watts
- T₃ = Modulation transformer, or full-in on 160 meters.



Here you are—an 807/push-pull 812/class B 811 combination that illustrates something of the amazing possibilities of the new RCA-811's and RCA-812's with their exclusive zirconium-coated anodes and low-loss Micanol bases! This may not be the last word in amateur rigs, but for a cw power input of 450 watts or a phone input of 310 watts, it is mighty difficult to beat. Tube cost figures and over-all performance speak for themselves!

The general transmitter layout illustrated is recommended for 10, 20, 40, 80 and 160 meter operation. Commercial plug-in coils may be used if desired, but C₁₅ will ordinarily require a larger capacitance to hit resonance on 80 and 160 meters.

Chassis illustrated is designed for either "table-top" or rack-and-panel

mounting. It measures 10" x 17" x 3". The two 6.3 volt filament transformers, various by-pass condensers and resistors are mounted underneath. A separate filament transformer for the 812's permits center-tap keying for cw operation. Push-pull 811's may be used in the same circuit by changing grid leak R₄ to 1250 ohms (20 watts).

Additional applications showing the outstanding results obtainable with the record-breaking new RCA-811's and RCA-812's are given in 'Ham Tips' for October, 1939. Copies are free from RCA distributors or from the Commercial Engineering Section, RCA Mfg. Co., Inc., Harrison, New Jersey.

The Big 3.

RCA-807

Beam Power Tetrode

Plate voltage, 750 V.

Plate input, 7.5 W.

Plate dissipation, 30 W.

Amateur Net \$3.50

RCA-811

High-Mu Triode

Plate voltage, 1500 V.

Plate input, 225 W.

Plate dissipation, 55 W.

Amateur Net \$3.50 each

RCA-812

Medium Mu Triode

Above ratings are the new RCA ICAS Ratings—(Intermittent Commercial and Amateur Service). They are well suited for many intermittent services which demand low initial cost and maximum power output. CCS (Continuous Commercial Service) Ratings remain the same as the old maximum RCA Ratings. Write for Bulletin.



RCA MANUFACTURING
CO., INC., CAMDEN, N. J.

A Service of the Radio
Corporation of America

Radio Tubes

FIRST IN METAL—FOREMOST IN GLASS—FINEST IN PERFORMANCE

